

Solives Nordic avec une entaille sur le côté de la semelle supérieure

Cette note technique sert de guide lorsque les solives en I Nordic sont endommagées.

Cette note technique est applicable seulement si les hypothèses suivantes sont respectées :

1. Une entaille maximum par solive.
2. L'entaille est située sur le côté de la semelle supérieure.
3. La profondeur de l'entaille est inférieure ou égale à 1 pouce.
4. La longueur de l'entaille est inférieure ou égale à 4 pouces.
5. Pour les portées multiples, les portées extérieures sont supérieures à 40% de la portée adjacente et l'entaille est située entre la mi-portée et l'extrémité (voir le dessin en bas à gauche).
6. Charges uniformément distribuées.

Pour tous les autres cas, voici les options :

- a. Remplacer la solive endommagée;
- b. Ajouter une nouvelle solive à moins de trois pouces de la solive entaillée;
 - Vérifier la portée maximale du revêtement pour l'espacement augmenté.
 - Vérifier la résistance de la solive en portée simple.
- c. Contacter le support technique de Nordic.

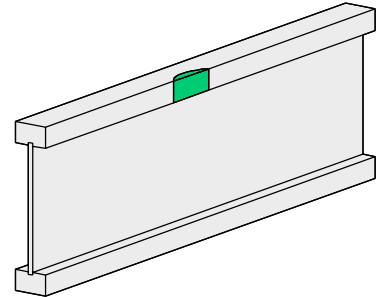

Les tableaux suivants indiquent les portées maximales pour les solives en I Nordic avec une entaille sur le côté de la semelle supérieure, pour des portées simples et multiples, et des profondeurs d'entaille de 1/2 et 1 pouce, avec et sans réparation. À noter que lorsqu'il y a peu de différences, les portées sont gouvernées par le critère de vibration. Les dessins ci-dessous illustrent la position de l'entaille à partir de l'appui le plus près, x , ainsi que sa profondeur et sa longueur.

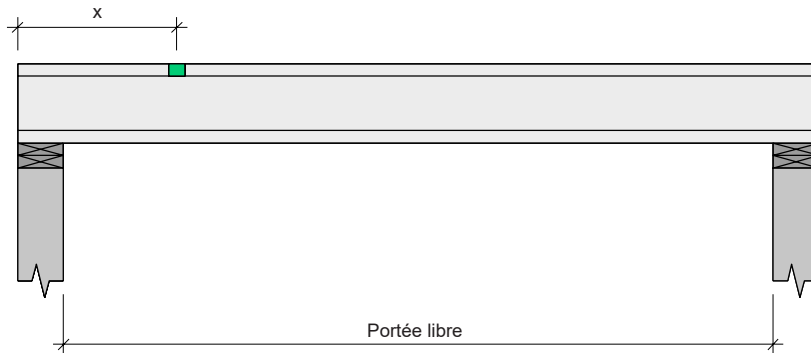

Vue en élévation d'une solive en portée simple et position de l'entaille

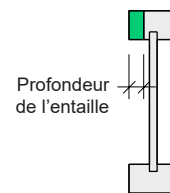

Profondeur de l'entaille

Vue en coupe

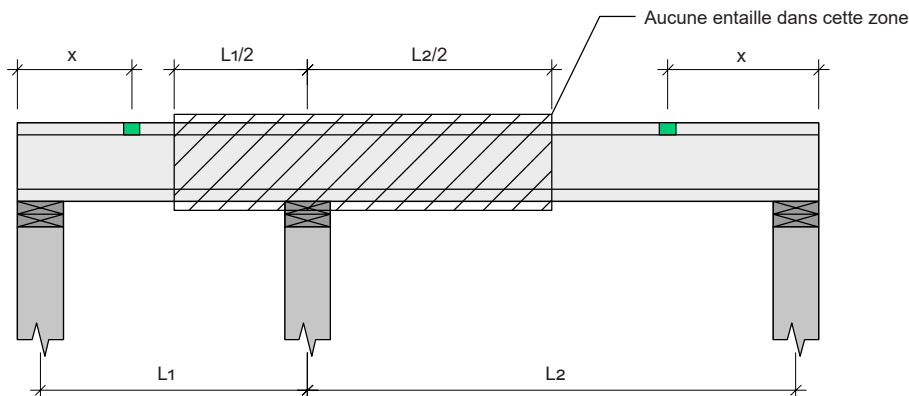

Vue en élévation d'une solive en portées multiples et position de l'entaille

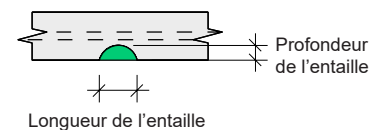

Longueur de l'entaille

Vue en plan

Option de réparation pour les solives Nordic avec une entaille sur le côté de la semelle supérieure

Les options suivantes sont applicables aux solives en I Nordic ayant une entaille sur le côté de la semelle supérieure, seulement si les hypothèses décrites à la page 1 sont respectées. Dans les tableaux suivants, les colonnes « sans réparation » (Non rép.) indiquent les portées maximales ne nécessitant aucune réparation, tandis que les colonnes « avec réparation » (Réparée) indiquent les portées maximales lorsqu'une réparation est requise.

Détail de réparation :

1. Installer un renfort 2x4 S-P-F No. 2 ou meilleur, d'une longueur de 4 pieds minimum, sur l'un ou l'autre des côtés de la semelle supérieure.
2. Le renfort doit être centré sur l'entaille, ou installé à partir de l'appui si l'entaille est à une distance de 2 pieds ou moins de l'appui.
3. Fixer le renfort avec des clous ordinaires de 2-1/2 pouces de longueur à 3 pouces centre/centre, tel que montré.

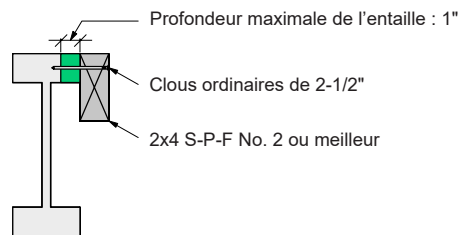

Vue en coupe d'une solive réparée

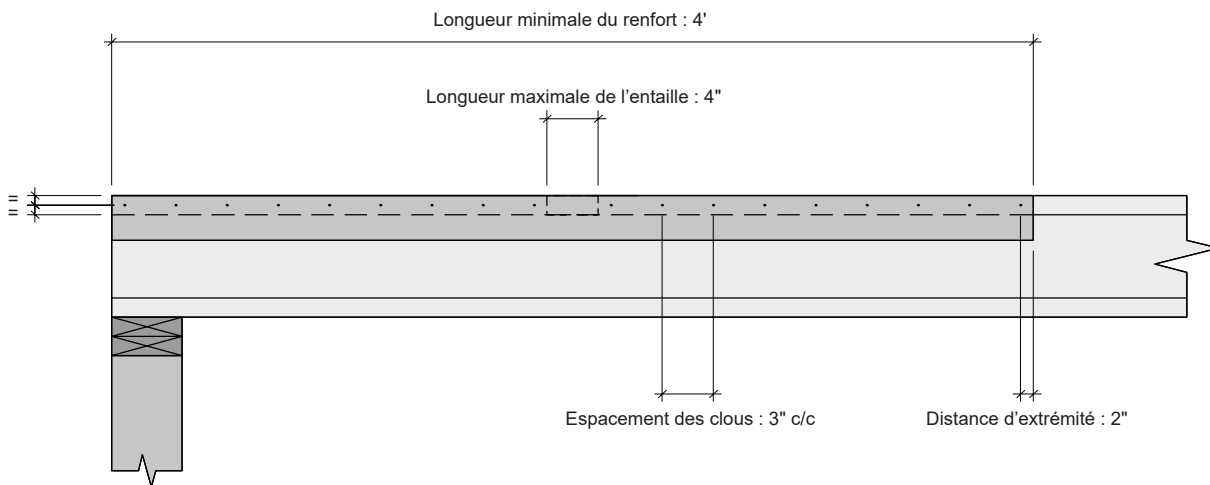

Vue en élévation d'une solive réparée

Critères de conception

Profondeur de l'entaille :	1/2 po
Portée :	Portée simple
Charges :	Surcharge = 40 lbf/pi ² et charge permanente = 15 lbf/pi ²
Limites de flèche :	L/480 sous la surcharge et L/240 sous la charge totale
Revêtement :	Panneaux de copeaux orientés (OSB) 5/8 po, cloué et collé

Portées maximales de plancher

Solive seule

Hauteur	Série	Position de l'entaille (x) ≤ 4 pi								Position de l'entaille (x) ≤ 8 pi							
		Espaceur centre/centre								Espaceur centre/centre							
		12"		16"		19,2"		24"		12"		16"		19,2"		24"	
		Non rép.	Réparée	Non rép.	Réparée	Non rép.	Réparée	Non rép.	Réparée	Non rép.	Réparée	Non rép.	Réparée	Non rép.	Réparée		
9-1/2"	NI-20	15'-1"	15'-1"	14'-3"	14'-3"	13'-9"	13'-10"	n.d.	n.d.	-	-	-	-	-	-	n.d.	n.d.
	NI-40x	16'-1"	16'-2"	15'-2"	15'-3"	14'-8"	14'-8"	n.d.	n.d.	16'-1"	16'-2"	-	-	-	-	n.d.	n.d.
	NI-60	16'-3"	16'-4"	15'-4"	15'-4"	14'-10"	14'-10"	n.d.	n.d.	16'-3"	16'-4"	-	-	-	-	n.d.	n.d.
	NI-80	17'-3"	17'-3"	16'-3"	16'-3"	15'-8"	15'-8"	n.d.	n.d.	17'-3"	17'-3"	16'-2"	16'-3"	-	-	n.d.	n.d.
11-7/8"	NI-20	16'-11"	17'-0"	16'-0"	16'-0"	15'-6"	15'-6"	n.d.	n.d.	16'-11"	17'-0"	16'-0"	16'-0"	-	-	n.d.	n.d.
	NI-40x	18'-1"	18'-2"	17'-0"	17'-1"	16'-5"	16'-6"	n.d.	n.d.	18'-1"	18'-2"	17'-0"	17'-1"	16'-5"	16'-6"	n.d.	n.d.
	NI-60	18'-4"	18'-5"	17'-2"	17'-3"	16'-7"	16'-8"	n.d.	n.d.	18'-4"	18'-5"	17'-2"	17'-3"	16'-7"	16'-8"	n.d.	n.d.
	NI-80	19'-9"	19'-9"	18'-3"	18'-3"	17'-6"	17'-7"	n.d.	n.d.	19'-9"	19'-9"	18'-2"	18'-3"	17'-6"	17'-7"	n.d.	n.d.
14"	NI-90	20'-2"	20'-2"	18'-7"	18'-8"	17'-10"	17'-10"	n.d.	n.d.	20'-2"	20'-2"	18'-7"	18'-8"	17'-9"	17'-10"	n.d.	n.d.
	NI-40x	20'-0"	20'-1"	18'-7"	18'-8"	17'-10"	17'-10"	n.d.	n.d.	20'-0"	20'-1"	18'-7"	18'-8"	17'-10"	17'-10"	n.d.	n.d.
	NI-60	20'-5"	20'-6"	18'-10"	18'-11"	18'-1"	18'-2"	n.d.	n.d.	20'-5"	20'-6"	18'-10"	18'-11"	18'-1"	18'-2"	n.d.	n.d.
	NI-80	21'-11"	21'-11"	20'-3"	20'-3"	19'-4"	19'-4"	n.d.	n.d.	21'-10"	21'-11"	20'-3"	20'-3"	19'-4"	19'-4"	n.d.	n.d.
16"	NI-90	22'-5"	22'-5"	20'-8"	20'-8"	19'-9"	19'-9"	n.d.	n.d.	22'-4"	22'-5"	20'-7"	20'-8"	19'-8"	19'-9"	n.d.	n.d.
	NI-60	22'-3"	22'-4"	20'-7"	20'-8"	19'-8"	19'-8"	n.d.	n.d.	22'-3"	22'-4"	20'-7"	20'-8"	19'-8"	19'-9"	n.d.	n.d.
	NI-80	23'-11"	23'-11"	22'-1"	22'-1"	21'-1"	21'-1"	n.d.	n.d.	23'-10"	23'-11"	22'-0"	22'-1"	21'-0"	21'-1"	n.d.	n.d.
	NI-90	24'-4"	24'-5"	22'-6"	22'-6"	21'-5"	21'-6"	n.d.	n.d.	24'-4"	24'-5"	22'-5"	22'-6"	21'-5"	21'-6"	n.d.	n.d.

Plaque de plâtre 1/2 po

Hauteur	Série	Position de l'entaille (x) ≤ 4 pi								Position de l'entaille (x) ≤ 8 pi							
		Espaceur centre/centre								Espaceur centre/centre							
		12"		16"		19,2"		24"		12"		16"		19,2"		24"	
		Non rép.	Réparée	Non rép.	Réparée	Non rép.	Réparée	Non rép.	Réparée	Non rép.	Réparée	Non rép.	Réparée	Non rép.	Réparée		
9-1/2"	NI-20	15'-7"	15'-7"	14'-8"	14'-9"	14'-3"	14'-3"	n.d.	n.d.	-	-	-	-	-	-	n.d.	n.d.
	NI-40x	16'-6"	16'-7"	15'-7"	15'-8"	15'-1"	15'-1"	n.d.	n.d.	16'-6"	16'-7"	-	-	-	-	n.d.	n.d.
	NI-60	16'-8"	16'-9"	15'-9"	15'-9"	15'-2"	15'-3"	n.d.	n.d.	16'-8"	16'-9"	15'-9"	15'-9"	-	-	n.d.	n.d.
	NI-80	17'-7"	17'-8"	16'-7"	16'-7"	16'-0"	16'-0"	n.d.	n.d.	17'-7"	17'-8"	16'-7"	16'-7"	16'-0"	16'-0"	n.d.	n.d.
11-7/8"	NI-20	17'-6"	17'-6"	16'-7"	16'-7"	16'-0"	16'-0"	n.d.	n.d.	17'-6"	17'-6"	16'-6"	16'-7"	16'-0"	16'-0"	n.d.	n.d.
	NI-40x	18'-9"	18'-9"	17'-6"	17'-6"	16'-11"	16'-11"	n.d.	n.d.	18'-8"	18'-9"	17'-6"	17'-6"	16'-11"	16'-11"	n.d.	n.d.
	NI-60	19'-0"	19'-0"	17'-8"	17'-8"	17'-1"	17'-1"	n.d.	n.d.	18'-11"	19'-0"	17'-8"	17'-8"	17'-1"	17'-1"	n.d.	n.d.
	NI-80	20'-4"	20'-4"	18'-9"	18'-10"	17'-11"	18'-0"	n.d.	n.d.	20'-3"	20'-4"	18'-9"	18'-10"	17'-11"	18'-0"	n.d.	n.d.
14"	NI-90	20'-8"	20'-9"	19'-2"	19'-2"	18'-3"	18'-4"	n.d.	n.d.	20'-8"	20'-9"	19'-1"	19'-2"	18'-3"	18'-4"	n.d.	n.d.
	NI-40x	20'-10"	20'-10"	19'-4"	19'-4"	18'-6"	18'-6"	n.d.	n.d.	20'-9"	20'-10"	19'-3"	19'-4"	18'-5"	18'-6"	n.d.	n.d.
	NI-60	21'-2"	21'-2"	19'-7"	19'-8"	18'-9"	18'-9"	n.d.	n.d.	21'-1"	21'-2"	19'-7"	19'-8"	18'-9"	18'-9"	n.d.	n.d.
	NI-80	22'-7"	22'-7"	20'-11"	20'-11"	19'-11"	20'-0"	n.d.	n.d.	22'-7"	22'-7"	20'-10"	20'-11"	19'-11"	20'-0"	n.d.	n.d.
16"	NI-90	23'-0"	23'-0"	21'-3"	21'-4"	20'-4"	20'-4"	n.d.	n.d.	22'-11"	23'-0"	21'-3"	21'-4"	20'-3"	20'-4"	n.d.	n.d.
	NI-60	23'-1"	23'-1"	21'-5"	21'-5"	20'-5"	20'-6"	n.d.	n.d.	23'-0"	23'-1"	21'-4"	21'-5"	20'-5"	20'-6"	n.d.	n.d.
	NI-80	24'-7"	24'-8"	22'-9"	22'-10"	21'-9"	21'-9"	n.d.	n.d.	24'-7"	24'-8"	22'-9"	22'-10"	21'-9"	21'-9"	n.d.	n.d.
	NI-90	25'-1"	25'-1"	23'-2"	23'-2"	22'-1"	22'-2"	n.d.	n.d.	25'-0"	25'-1"	23'-1"	23'-2"	22'-1"	22'-2"	n.d.	n.d.

Notes :

1. Les portées libres indiquées s'appliquent à la construction de planchers résidentiels respectant les critères de conception ci-dessus.
2. La longueur d'appui minimale est de 1-3/4 pouce pour les appuis d'extrémité et de 3-1/2 pouces pour les appuis intermédiaires.
3. Les raidisseurs d'appui ne sont pas requis lorsque les solives sont utilisées conformément à ces tableaux, sauf si requis pour les étriers.
4. Pour les hypothèses de calcul, voir la page 1. Pour le détail de réparation, voir la page 2.

Critères de conception

Profondeur de l'entaille :	1/2 po
Portée :	Portées multiples
Charges :	Surcharge = 40 lbf/pi ² et charge permanente = 15 lbf/pi ²
Limites de flèche :	L/480 sous la surcharge et L/240 sous la charge totale
Revêtement :	Panneaux de copeaux orientés (OSB) 5/8 po, cloué et collé

Portées maximales de plancher

Solive seule

Hauteur	Série	Position de l'entaille (x) ≤ 4 pi								Position de l'entaille (x) ≤ 8 pi							
		Espaceur centre/centre								Espaceur centre/centre							
		12"		16"		19,2"		24"		12"		16"		19,2"		24"	
		Non rép.	Réparée	Non rép.	Réparée	Non rép.	Réparée	Non rép.	Réparée	Non rép.	Réparée	Non rép.	Réparée	Non rép.	Réparée	Non rép.	Réparée
9-1/2"	NI-20	16'-3"	16'-3"	15'-4"	15'-4"	14'-10"	14'-10"	n.d.	n.d.	16'-2"	16'-3"	-	-	-	-	n.d.	n.d.
	NI-40x	17'-4"	17'-5"	16'-4"	16'-5"	15'-10"	15'-10"	n.d.	n.d.	17'-4"	17'-5"	16'-4"	16'-5"	15'-9"	15'-10"	n.d.	n.d.
	NI-60	17'-6"	17'-7"	16'-6"	16'-7"	16'-0"	16'-0"	n.d.	n.d.	17'-6"	17'-7"	16'-6"	16'-7"	15'-11"	16'-0"	n.d.	n.d.
	NI-80	18'-10"	18'-10"	17'-6"	17'-6"	16'-11"	16'-11"	n.d.	n.d.	18'-9"	18'-10"	17'-6"	17'-6"	16'-10"	16'-11"	n.d.	n.d.
11-7/8"	NI-20	18'-5"	18'-5"	17'-3"	17'-3"	16'-8"	16'-9"	n.d.	n.d.	18'-4"	18'-5"	17'-3"	17'-3"	16'-8"	16'-9"	n.d.	n.d.
	NI-40x	19'-11"	20'-0"	18'-6"	18'-7"	17'-9"	17'-9"	n.d.	n.d.	19'-11"	20'-0"	18'-6"	18'-7"	17'-9"	17'-9"	n.d.	n.d.
	NI-60	20'-2"	20'-3"	18'-9"	18'-10"	17'-11"	18'-0"	n.d.	n.d.	20'-2"	20'-3"	18'-9"	18'-10"	17'-11"	18'-0"	n.d.	n.d.
	NI-80	21'-9"	21'-10"	20'-2"	20'-2"	19'-3"	19'-3"	n.d.	n.d.	21'-9"	21'-10"	20'-1"	20'-2"	19'-2"	19'-3"	n.d.	n.d.
14"	NI-90	22'-3"	22'-3"	20'-7"	20'-7"	19'-8"	19'-8"	n.d.	n.d.	22'-3"	22'-3"	20'-6"	20'-7"	19'-7"	19'-8"	n.d.	n.d.
	NI-40x	22'-2"	22'-2"	20'-6"	20'-7"	19'-8"	19'-8"	n.d.	n.d.	22'-1"	22'-2"	20'-6"	20'-7"	19'-7"	19'-8"	n.d.	n.d.
	NI-60	22'-6"	22'-7"	20'-10"	20'-11"	19'-11"	20'-0"	n.d.	n.d.	22'-6"	22'-7"	20'-10"	20'-11"	19'-11"	20'-0"	n.d.	n.d.
	NI-80	24'-3"	24'-3"	22'-5"	22'-5"	21'-4"	21'-5"	n.d.	n.d.	24'-2"	24'-3"	22'-4"	22'-5"	21'-4"	21'-5"	n.d.	n.d.
16"	NI-90	24'-9"	24'-9"	22'-10"	22'-10"	21'-9"	21'-10"	n.d.	n.d.	24'-8"	24'-9"	22'-10"	22'-10"	21'-9"	21'-10"	n.d.	n.d.
	NI-60	24'-6"	24'-7"	22'-9"	22'-10"	21'-8"	21'-9"	n.d.	n.d.	24'-6"	24'-7"	22'-9"	22'-10"	21'-8"	21'-9"	n.d.	n.d.
	NI-80	26'-5"	26'-5"	24'-5"	24'-5"	23'-3"	23'-4"	n.d.	n.d.	26'-5"	26'-5"	24'-4"	24'-5"	23'-3"	23'-4"	n.d.	n.d.
	NI-90	26'-11"	26'-11"	24'-10"	24'-11"	23'-8"	23'-9"	n.d.	n.d.	26'-11"	26'-11"	24'-10"	24'-11"	23'-8"	23'-9"	n.d.	n.d.

Plaque de plâtre 1/2 po

Hauteur	Série	Position de l'entaille (x) ≤ 4 pi								Position de l'entaille (x) ≤ 8 pi							
		Espaceur centre/centre								Espaceur centre/centre							
		12"		16"		19,2"		24"		12"		16"		19,2"		24"	
		Sans rép.	Avec rép.	Non rép.	Réparée	Non rép.	Réparée	Non rép.	Réparée	Non rép.	Réparée	Non rép.	Réparée	Non rép.	Réparée	Non rép.	Réparée
9-1/2"	NI-20	16'-9"	16'-10"	15'-10"	15'-11"	15'-4"	15'-5"	n.d.	n.d.	16'-9"	16'-10"	15'-10"	15'-11"	-	-	n.d.	n.d.
	NI-40x	17'-10"	17'-11"	16'-10"	16'-11"	16'-3"	16'-4"	n.d.	n.d.	17'-10"	17'-11"	16'-10"	16'-11"	16'-3"	16'-4"	n.d.	n.d.
	NI-60	18'-1"	18'-1"	17'-0"	17'-0"	16'-5"	16'-5"	n.d.	n.d.	18'-0"	18'-1"	17'-0"	17'-0"	16'-5"	16'-5"	n.d.	n.d.
	NI-80	19'-5"	19'-5"	17'-11"	18'-0"	17'-4"	17'-4"	n.d.	n.d.	19'-4"	19'-5"	17'-11"	18'-0"	17'-3"	17'-4"	n.d.	n.d.
11-7/8"	NI-20	19'-2"	19'-3"	17'-11"	17'-11"	17'-3"	17'-4"	n.d.	n.d.	19'-2"	19'-3"	17'-10"	17'-11"	17'-3"	17'-4"	n.d.	n.d.
	NI-40x	20'-8"	20'-8"	19'-3"	19'-3"	18'-5"	18'-5"	n.d.	n.d.	20'-8"	20'-8"	19'-2"	19'-3"	18'-4"	18'-5"	n.d.	n.d.
	NI-60	20'-11"	21'-0"	19'-6"	19'-6"	18'-7"	18'-8"	n.d.	n.d.	20'-11"	21'-0"	19'-5"	19'-6"	18'-7"	18'-8"	n.d.	n.d.
	NI-80	22'-5"	22'-5"	20'-9"	20'-10"	19'-10"	19'-10"	n.d.	n.d.	22'-5"	22'-5"	20'-9"	20'-10"	19'-10"	19'-10"	n.d.	n.d.
14"	NI-90	22'-11"	22'-11"	21'-2"	21'-2"	20'-3"	20'-3"	n.d.	n.d.	22'-10"	22'-11"	21'-2"	21'-2"	20'-2"	20'-3"	n.d.	n.d.
	NI-40x	23'-0"	23'-0"	21'-4"	21'-4"	20'-5"	20'-6"	n.d.	n.d.	22'-11"	23'-0"	21'-4"	21'-4"	20'-5"	20'-6"	n.d.	n.d.
	NI-60	23'-4"	23'-4"	21'-8"	21'-8"	20'-9"	20'-9"	n.d.	n.d.	23'-4"	23'-4"	21'-8"	21'-8"	20'-8"	20'-9"	n.d.	n.d.
	NI-80	25'-0"	25'-0"	23'-1"	23'-2"	22'-1"	22'-1"	n.d.	n.d.	24'-11"	25'-0"	23'-1"	23'-2"	22'-1"	22'-1"	n.d.	n.d.
16"	NI-90	25'-5"	25'-6"	23'-7"	23'-7"	22'-6"	22'-6"	n.d.	n.d.	25'-5"	25'-6"	23'-6"	23'-7"	22'-5"	22'-6"	n.d.	n.d.
	NI-60	25'-6"	25'-6"	23'-8"	23'-8"	22'-8"	22'-8"	n.d.	n.d.	25'-5"	25'-6"	23'-7"	23'-8"	22'-7"	22'-8"	n.d.	n.d.
	NI-80	27'-3"	27'-3"	25'-3"	25'-3"	24'-1"	24'-1"	n.d.	n.d.	27'-2"	27'-3"	25'-2"	25'-3"	24'-1"	24'-1"	n.d.	n.d.
	NI-90	27'-9"	27'-9"	25'-8"	25'-8"	24'-6"	24'-6"	n.d.	n.d.	27'-8"	27'-9"	25'-7"	25'-8"	24'-5"	24'-6"	n.d.	n.d.

Notes :

1. Les portées libres indiquées s'appliquent à la construction de planchers résidentiels respectant les critères de conception ci-dessus.
2. La longueur d'appui minimale est de 1-3/4 pouce pour les appuis d'extrémité et de 3-1/2 pouces pour les appuis intermédiaires.
3. Les raidisseurs d'appui ne sont pas requis lorsque les solives sont utilisées conformément à ces tableaux, sauf si requis pour les étriers.
4. Pour les hypothèses de calcul, voir la page 1. Pour le détail de réparation, voir la page 2.

Critères de conception

Profondeur de l'entaille :	1/2 po
Portée :	Portée simple
Charges :	Surcharge = 40 lbf/pi ² et charge permanente = 15 lbf/pi ²
Limites de flèche :	L/480 sous la surcharge et L/240 sous la charge totale
Revêtement :	Panneaux de copeaux orientés (OSB) 3/4 po, cloué et collé

Portées maximales de plancher

Solive seule

Hauteur	Série	Position de l'entaille (x) ≤ 4 pi								Position de l'entaille (x) ≤ 8 pi							
		Espaceur centre/centre								Espaceur centre/centre							
		12"		16"		19,2"		24"		12"		16"		19,2"		24"	
		Non rép.	Réparée	Non rép.	Réparée	Non rép.	Réparée	Non rép.	Réparée	Non rép.	Réparée	Non rép.	Réparée	Non rép.	Réparée		
9-1/2"	NI-20	15'-11"	15'-11"	15'-0"	15'-1"	14'-5"	14'-6"	13'-4"	13'-5"	15'-10"	15'-11"	-	-	-	-	-	
	NI-40x	17'-0"	17'-0"	16'-0"	16'-0"	15'-5"	15'-5"	14'-9"	14'-10"	16'-11"	17'-0"	15'-11"	16'-0"	-	-	-	
	NI-60	17'-1"	17'-2"	16'-2"	16'-2"	15'-6"	15'-7"	14'-11"	14'-11"	17'-1"	17'-2"	16'-1"	16'-2"	-	-	-	
	NI-80	18'-2"	18'-3"	17'-1"	17'-1"	16'-5"	16'-5"	15'-9"	15'-9"	18'-2"	18'-3"	17'-0"	17'-1"	16'-5"	16'-5"	15'-8"	15'-9"
11-7/8"	NI-20	17'-10"	17'-11"	16'-10"	16'-11"	16'-3"	16'-3"	15'-7"	15'-8"	17'-10"	17'-11"	16'-10"	16'-11"	16'-3"	16'-3"	-	
	NI-40x	19'-4"	19'-4"	17'-11"	17'-11"	17'-3"	17'-3"	16'-6"	16'-7"	19'-3"	19'-4"	17'-11"	17'-11"	17'-3"	17'-3"	15'-8"	16'-7"
	NI-60	19'-6"	19'-7"	18'-2"	18'-2"	17'-5"	17'-6"	16'-8"	16'-9"	19'-6"	19'-7"	18'-1"	18'-2"	17'-5"	17'-6"	16'-8"	16'-9"
	NI-80	21'-0"	21'-1"	19'-5"	19'-6"	18'-5"	18'-6"	17'-6"	17'-7"	21'-0"	21'-1"	19'-5"	19'-6"	18'-5"	18'-6"	17'-6"	17'-7"
14"	NI-90	21'-6"	21'-6"	19'-9"	19'-10"	18'-10"	18'-11"	17'-10"	17'-11"	21'-5"	21'-6"	19'-9"	19'-10"	18'-10"	18'-11"	17'-10"	17'-11"
	NI-40x	21'-5"	21'-5"	19'-10"	19'-11"	18'-11"	18'-11"	17'-11"	18'-0"	21'-5"	21'-5"	19'-10"	19'-11"	18'-10"	18'-11"	17'-4"	18'-0"
	NI-60	21'-9"	21'-10"	20'-1"	20'-2"	19'-2"	19'-3"	18'-2"	18'-3"	21'-9"	21'-10"	20'-1"	20'-2"	19'-2"	19'-3"	18'-2"	18'-3"
	NI-80	23'-4"	23'-5"	21'-6"	21'-7"	20'-6"	20'-7"	19'-5"	19'-5"	23'-4"	23'-5"	21'-6"	21'-7"	20'-6"	20'-7"	19'-5"	19'-5"
16"	NI-90	23'-10"	23'-10"	22'-0"	22'-1"	20'-11"	21'-0"	19'-9"	19'-10"	23'-10"	23'-10"	22'-0"	22'-1"	20'-11"	21'-0"	19'-9"	19'-10"
	NI-60	23'-8"	23'-9"	22'-0"	22'-0"	20'-11"	21'-0"	19'-10"	19'-10"	23'-8"	23'-9"	22'-0"	22'-0"	20'-11"	21'-0"	19'-9"	19'-10"
	NI-80	25'-6"	25'-6"	23'-6"	23'-7"	22'-4"	22'-5"	21'-2"	21'-2"	25'-5"	25'-6"	23'-6"	23'-7"	22'-4"	22'-5"	21'-1"	21'-2"
	NI-90	25'-11"	26'-0"	23'-11"	24'-0"	22'-9"	22'-10"	21'-5"	21'-6"	25'-11"	26'-0"	23'-11"	24'-0"	22'-9"	22'-10"	21'-5"	21'-6"

Plaque de plâtre 1/2 po

Hauteur	Série	Position de l'entaille (x) ≤ 4 pi								Position de l'entaille (x) ≤ 8 pi							
		Espaceur centre/centre								Espaceur centre/centre							
		12"		16"		19,2"		24"		12"		16"		19,2"		24"	
		Non rép.	Réparée	Non rép.	Réparée	Non rép.	Réparée	Non rép.	Réparée	Non rép.	Réparée	Non rép.	Réparée	Non rép.	Réparée		
9-1/2"	NI-20	16'-4"	16'-5"	15'-4"	15'-5"	14'-5"	14'-6"	13'-4"	13'-5"	16'-4"	16'-5"	-	-	-	-	-	
	NI-40x	17'-4"	17'-5"	16'-5"	16'-5"	15'-9"	15'-9"	15'-1"	15'-2"	17'-4"	17'-5"	16'-4"	16'-5"	15'-5"	15'-10"	-	
	NI-60	17'-6"	17'-7"	16'-6"	16'-7"	15'-11"	16'-0"	15'-3"	15'-4"	17'-6"	17'-7"	16'-6"	16'-7"	15'-11"	16'-0"	-	
	NI-80	18'-8"	18'-8"	17'-5"	17'-5"	16'-9"	16'-9"	16'-1"	16'-1"	18'-7"	18'-8"	17'-5"	17'-5"	16'-9"	16'-9"	16'-0"	16'-1"
11-7/8"	NI-20	18'-6"	18'-7"	17'-5"	17'-5"	16'-9"	16'-10"	16'-1"	16'-2"	18'-6"	18'-7"	17'-4"	17'-5"	16'-8"	16'-10"	14'-11"	16'-2"
	NI-40x	19'-11"	19'-11"	18'-6"	18'-6"	17'-8"	17'-8"	17'-0"	17'-0"	19'-11"	19'-11"	18'-6"	18'-6"	17'-8"	17'-9"	15'-8"	17'-0"
	NI-60	20'-2"	20'-2"	18'-9"	18'-9"	17'-10"	17'-11"	17'-2"	17'-2"	20'-2"	20'-2"	18'-8"	18'-9"	17'-10"	17'-11"	17'-1"	17'-2"
	NI-80	21'-7"	21'-7"	20'-0"	20'-0"	19'-0"	19'-0"	18'-0"	18'-0"	21'-6"	21'-7"	19'-11"	20'-0"	19'-0"	19'-0"	18'-0"	18'-0"
14"	NI-90	22'-0"	22'-0"	20'-4"	20'-4"	19'-4"	19'-5"	18'-4"	18'-4"	21'-11"	22'-0"	20'-4"	20'-4"	19'-4"	19'-5"	18'-3"	18'-4"
	NI-40x	22'-1"	22'-1"	20'-6"	20'-7"	19'-7"	19'-7"	18'-7"	18'-7"	22'-1"	22'-1"	20'-6"	20'-7"	19'-7"	19'-7"	17'-4"	18'-7"
	NI-60	22'-5"	22'-6"	20'-9"	20'-10"	19'-10"	19'-11"	18'-9"	18'-10"	22'-5"	22'-6"	20'-9"	20'-10"	19'-10"	19'-11"	18'-9"	18'-10"
	NI-80	24'-0"	24'-0"	22'-2"	22'-3"	21'-2"	21'-2"	20'-0"	20'-0"	23'-11"	24'-0"	22'-2"	22'-3"	21'-1"	21'-2"	20'-0"	20'-0"
16"	NI-90	24'-5"	24'-5"	22'-7"	22'-7"	21'-6"	21'-6"	20'-4"	20'-4"	24'-5"	24'-5"	22'-7"	22'-7"	21'-6"	21'-6"	20'-4"	20'-4"
	NI-60	24'-6"	24'-6"	22'-9"	22'-9"	21'-8"	21'-8"	20'-6"	20'-7"	24'-5"	24'-6"	22'-8"	22'-9"	21'-8"	21'-8"	20'-6"	20'-7"
	NI-80	26'-1"	26'-2"	24'-2"	24'-3"	23'-0"	23'-1"	21'-9"	21'-10"	26'-1"	26'-2"	24'-2"	24'-3"	23'-0"	23'-1"	21'-9"	21'-10"
	NI-90	26'-7"	26'-7"	24'-7"	24'-8"	23'-5"	23'-5"	22'-2"	22'-2"	26'-7"	26'-7"	24'-7"	24'-8"	23'-5"	23'-5"	22'-1"	22'-2"

Notes :

1. Les portées libres indiquées s'appliquent à la construction de planchers résidentiels respectant les critères de conception ci-dessus.
2. La longueur d'appui minimale est de 1-3/4 pouce pour les appuis d'extrémité et de 3-1/2 pouces pour les appuis intermédiaires.
3. Les raidisseurs d'appui ne sont pas requis lorsque les solives sont utilisées conformément à ces tableaux, sauf si requis pour les étriers.
4. Pour les hypothèses de calcul, voir la page 1. Pour le détail de réparation, voir la page 2.

Critères de conception

Profondeur de l'entaille :	1/2 po
Portée :	Portées multiples
Charges :	Surcharge = 40 lbf/pi ² et charge permanente = 15 lbf/pi ²
Limites de flèche :	L/480 sous la surcharge et L/240 sous la charge totale
Revêtement :	Panneaux de copeaux orientés (OSB) 3/4 po, cloué et collé

Portées maximales de plancher

Solive seule

Hauteur	Série	Position de l'entaille (x) ≤ 4 pi								Position de l'entaille (x) ≤ 8 pi							
		Espaceur centre/centre								Espaceur centre/centre							
		12"		16"		19,2"		24"		12"		16"		19,2"		24"	
		Non rép.	Réparée	Non rép.	Réparée	Non rép.	Réparée	Non rép.	Réparée	Non rép.	Réparée	Non rép.	Réparée	Non rép.	Réparée		
9-1/2"	NI-20	17'-1"	17'-2"	16'-2"	16'-2"	15'-7"	15'-8"	14'-6"	14'-7"	17'-1"	17'-2"	16'-2"	16'-2"	-	-	-	
	NI-40x	18'-4"	18'-5"	17'-3"	17'-3"	16'-7"	16'-8"	15'-5"	15'-5"	18'-4"	18'-5"	17'-2"	17'-3"	16'-7"	16'-8"	-	
	NI-60	18'-8"	18'-8"	17'-5"	17'-5"	16'-9"	16'-10"	16'-1"	16'-1"	18'-7"	18'-8"	17'-4"	17'-5"	16'-9"	16'-10"	16'-1"	16'-1"
	NI-80	20'-1"	20'-1"	18'-7"	18'-7"	17'-9"	17'-9"	17'-0"	17'-0"	20'-1"	20'-1"	18'-7"	18'-7"	17'-8"	17'-9"	16'-11"	17'-0"
11-7/8"	NI-20	19'-8"	19'-8"	18'-3"	18'-3"	17'-6"	17'-7"	16'-7"	16'-7"	19'-7"	19'-8"	18'-2"	18'-3"	17'-6"	17'-7"	16'-7"	16'-7"
	NI-40x	21'-3"	21'-4"	19'-9"	19'-9"	18'-10"	18'-10"	17'-7"	17'-7"	21'-3"	21'-4"	19'-8"	19'-9"	18'-9"	18'-10"	17'-7"	17'-7"
	NI-60	21'-7"	21'-8"	20'-0"	20'-1"	19'-1"	19'-1"	18'-1"	18'-1"	21'-7"	21'-8"	20'-0"	20'-1"	19'-0"	19'-1"	18'-0"	18'-1"
	NI-80	23'-2"	23'-3"	21'-5"	21'-6"	20'-4"	20'-5"	19'-3"	19'-4"	23'-2"	23'-3"	21'-5"	21'-6"	20'-4"	20'-5"	19'-3"	19'-4"
14"	NI-20	23'-8"	23'-8"	21'-11"	21'-11"	20'-10"	20'-10"	19'-9"	19'-9"	23'-8"	23'-8"	21'-10"	21'-11"	20'-10"	20'-10"	19'-8"	19'-9"
	NI-40x	23'-7"	23'-8"	21'-10"	21'-11"	20'-10"	20'-11"	19'-4"	19'-4"	23'-7"	23'-8"	21'-10"	21'-11"	20'-10"	20'-11"	19'-4"	19'-4"
	NI-60	24'-0"	24'-1"	22'-3"	22'-3"	21'-2"	21'-3"	20'-1"	20'-1"	24'-0"	24'-1"	22'-2"	22'-3"	21'-2"	21'-3"	20'-0"	20'-1"
	NI-80	25'-10"	25'-10"	23'-10"	23'-10"	22'-8"	22'-9"	21'-5"	21'-6"	25'-9"	25'-10"	23'-10"	23'-10"	22'-8"	22'-9"	21'-5"	21'-6"
16"	NI-60	26'-2"	26'-3"	24'-3"	24'-3"	23'-1"	23'-2"	21'-10"	21'-11"	26'-2"	26'-3"	24'-3"	24'-3"	23'-1"	23'-2"	21'-10"	21'-11"
	NI-80	28'-1"	28'-2"	26'-0"	26'-0"	24'-8"	24'-9"	23'-4"	23'-5"	28'-1"	28'-2"	25'-11"	26'-0"	24'-8"	24'-9"	23'-4"	23'-5"
	NI-90	28'-8"	28'-8"	26'-6"	26'-6"	25'-2"	25'-2"	23'-9"	23'-10"	28'-8"	28'-8"	26'-5"	26'-6"	25'-2"	25'-2"	23'-9"	23'-10"

Plaque de plâtre 1/2 po

Hauteur	Série	Position de l'entaille (x) ≤ 4 pi								Position de l'entaille (x) ≤ 8 pi							
		Espaceur centre/centre								Espaceur centre/centre							
		12"		16"		19,2"		24"		12"		16"		19,2"		24"	
		Non rép.	Réparée	Non rép.	Réparée	Non rép.	Réparée	Non rép.	Réparée	Non rép.	Réparée	Non rép.	Réparée	Non rép.	Réparée		
9-1/2"	NI-20	17'-8"	17'-8"	16'-8"	16'-9"	15'-9"	15'-9"	14'-6"	14'-7"	17'-8"	17'-8"	16'-8"	16'-9"	15'-8"	15'-9"	-	-
	NI-40x	19'-0"	19'-0"	17'-8"	17'-9"	17'-1"	17'-1"	15'-5"	15'-5"	19'-0"	19'-0"	17'-8"	17'-9"	17'-0"	17'-1"	-	-
	NI-60	19'-3"	19'-3"	17'-10"	17'-11"	17'-2"	17'-3"	16'-6"	16'-6"	19'-2"	19'-3"	17'-10"	17'-11"	17'-2"	17'-3"	16'-6"	16'-6"
	NI-80	20'-7"	20'-7"	19'-1"	19'-1"	18'-2"	18'-3"	17'-4"	17'-5"	20'-7"	20'-7"	19'-1"	19'-1"	18'-2"	18'-3"	17'-4"	17'-5"
11-7/8"	NI-20	20'-5"	20'-6"	19'-1"	19'-1"	18'-2"	18'-3"	16'-7"	16'-7"	20'-5"	20'-6"	19'-0"	19'-1"	18'-2"	18'-3"	16'-7"	16'-7"
	NI-40x	22'-0"	22'-0"	20'-5"	20'-6"	19'-6"	19'-6"	17'-7"	17'-7"	21'-11"	22'-0"	20'-5"	20'-6"	19'-6"	19'-6"	17'-7"	17'-7"
	NI-60	22'-3"	22'-3"	20'-8"	20'-9"	19'-9"	19'-9"	18'-9"	18'-9"	22'-3"	22'-3"	20'-8"	20'-9"	19'-9"	19'-9"	18'-8"	18'-9"
	NI-80	23'-10"	23'-10"	22'-1"	22'-1"	21'-0"	21'-1"	19'-11"	19'-11"	23'-9"	23'-10"	22'-0"	22'-1"	21'-0"	21'-1"	19'-10"	19'-11"
14"	NI-20	24'-3"	24'-4"	22'-6"	22'-6"	21'-5"	21'-5"	20'-3"	20'-4"	24'-3"	24'-4"	22'-6"	22'-6"	21'-5"	21'-5"	20'-3"	20'-4"
	NI-40x	24'-5"	24'-5"	22'-8"	22'-9"	21'-8"	21'-8"	19'-4"	19'-4"	24'-4"	24'-5"	22'-8"	22'-9"	21'-8"	21'-8"	19'-4"	19'-4"
	NI-60	24'-9"	24'-10"	23'-0"	23'-1"	22'-0"	22'-0"	20'-10"	20'-10"	24'-9"	24'-10"	23'-0"	23'-1"	21'-11"	22'-0"	20'-10"	20'-10"
	NI-80	26'-6"	26'-6"	24'-7"	24'-7"	23'-5"	23'-5"	22'-2"	22'-2"	26'-5"	26'-6"	24'-6"	24'-7"	23'-4"	23'-5"	22'-1"	22'-2"
16"	NI-60	27'-0"	27'-0"	25'-0"	25'-0"	23'-10"	23'-10"	22'-6"	22'-6"	26'-11"	27'-0"	25'-0"	25'-0"	23'-9"	23'-10"	22'-6"	22'-6"
	NI-80	28'-10"	28'-10"	26'-9"	26'-9"	25'-6"	25'-6"	24'-1"	24'-2"	27'-0"	27'-1"	25'-1"	25'-2"	23'-11"	24'-0"	22'-8"	22'-9"
	NI-90	29'-5"	29'-5"	27'-3"	27'-3"	25'-11"	25'-11"	24'-6"	24'-6"	29'-4"	29'-5"	27'-2"	27'-3"	25'-11"	25'-11"	24'-6"	24'-6"

Notes :

1. Les portées libres indiquées s'appliquent à la construction de planchers résidentiels respectant les critères de conception ci-dessus.
2. La longueur d'appui minimale est de 1-3/4 pouce pour les appuis d'extrémité et de 3-1/2 pouces pour les appuis intermédiaires.
3. Les raidisseurs d'appui ne sont pas requis lorsque les solives sont utilisées conformément à ces tableaux, sauf si requis pour les étriers.
4. Pour les hypothèses de calcul, voir la page 1. Pour le détail de réparation, voir la page 2.

Critères de conception

Profondeur de l'entaille :	1 po
Portée :	Portée simple
Charges :	Surcharge = 40 lbf/pi ² et charge permanente = 15 lbf/pi ²
Limites de flèche :	L/480 sous la surcharge et L/240 sous la charge totale
Revêtement :	Panneaux de copeaux orientés (OSB) 5/8 po, cloué et collé

Portées maximales de plancher

Solive seule

Hauteur	Série	Position de l'entaille (x) ≤ 4 pi								Position de l'entaille (x) ≤ 8 pi									
		Espaceur centre/centre								Espaceur centre/centre									
		12"		16"		19.2"		24"		12"		16"		19.2"		24"			
Non rép.		Réparée		Non rép.		Réparée		Non rép.		Réparée		Non rép.		Réparée		Non rép.		Réparée	
9-1/2"	NI-20	15'-0"	15'-1"	14'-2"	14'-3"	13'-8"	13'-10"	n.d.	n.d.	-	-	-	-	-	-	-	n.d.	n.d.	
	NI-40x	16'-1"	16'-2"	15'-1"	15'-3"	14'-7"	14'-8"	n.d.	n.d.	16'-0"	16'-2"	-	-	-	-	-	n.d.	n.d.	
	NI-60	16'-2"	16'-4"	15'-3"	15'-4"	14'-9"	14'-10"	n.d.	n.d.	16'-2"	16'-4"	-	-	-	-	-	n.d.	n.d.	
	NI-80	17'-2"	17'-3"	16'-2"	16'-3"	15'-7"	15'-8"	n.d.	n.d.	17'-1"	17'-3"	16'-1"	16'-3"	-	-	-	n.d.	n.d.	
11-7/8"	NI-20	16'-11"	17'-0"	15'-11"	16'-0"	15'-5"	15'-6"	n.d.	n.d.	16'-10"	17'-0"	15'-8"	16'-0"	-	-	-	n.d.	n.d.	
	NI-40x	18'-0"	18'-2"	16'-11"	17'-1"	16'-4"	16'-6"	n.d.	n.d.	17'-11"	18'-2"	16'-7"	17'-1"	15'-1"	16'-6"	-	n.d.	n.d.	
	NI-60	18'-3"	18'-5"	17'-2"	17'-3"	16'-7"	16'-8"	n.d.	n.d.	18'-2"	18'-5"	17'-1"	17'-3"	16'-6"	16'-8"	-	n.d.	n.d.	
	NI-80	19'-8"	19'-9"	18'-2"	18'-3"	17'-6"	17'-7"	n.d.	n.d.	19'-7"	19'-9"	18'-1"	18'-3"	17'-5"	17'-7"	-	n.d.	n.d.	
14"	NI-90	20'-1"	20'-2"	18'-6"	18'-8"	17'-9"	17'-10"	n.d.	n.d.	20'-0"	20'-2"	18'-5"	18'-8"	17'-8"	17'-10"	-	n.d.	n.d.	
	NI-40x	20'-0"	20'-1"	18'-6"	18'-8"	17'-9"	17'-10"	n.d.	n.d.	19'-11"	20'-1"	18'-4"	18'-8"	16'-7"	17'-10"	-	n.d.	n.d.	
	NI-60	20'-4"	20'-6"	18'-10"	18'-11"	18'-0"	18'-2"	n.d.	n.d.	20'-3"	20'-6"	18'-9"	18'-11"	17'-11"	18'-2"	-	n.d.	n.d.	
	NI-80	21'-10"	21'-11"	20'-2"	20'-3"	19'-3"	19'-4"	n.d.	n.d.	21'-9"	21'-11"	20'-1"	20'-3"	19'-2"	19'-4"	-	n.d.	n.d.	
16"	NI-90	22'-4"	22'-5"	20'-7"	20'-8"	19'-8"	19'-9"	n.d.	n.d.	22'-3"	22'-5"	20'-6"	20'-8"	19'-7"	19'-9"	-	n.d.	n.d.	
	NI-60	22'-2"	22'-4"	20'-6"	20'-8"	19'-8"	19'-9"	n.d.	n.d.	22'-1"	22'-4"	20'-5"	20'-8"	19'-7"	19'-9"	-	n.d.	n.d.	
	NI-80	23'-10"	23'-11"	22'-0"	22'-1"	21'-0"	21'-1"	n.d.	n.d.	23'-9"	23'-11"	21'-11"	22'-1"	20'-11"	21'-1"	-	n.d.	n.d.	
	NI-90	24'-4"	24'-5"	22'-5"	22'-6"	21'-5"	21'-6"	n.d.	n.d.	24'-3"	24'-5"	22'-4"	22'-6"	21'-3"	21'-6"	-	n.d.	n.d.	

Plaque de plâtre 1/2 po

Hauteur	Série	Position de l'entaille (x) ≤ 4 pi								Position de l'entaille (x) ≤ 8 pi									
		Espaceur centre/centre								Espaceur centre/centre									
		12"		16"		19.2"		24"		12"		16"		19.2"		24"			
Non rép.		Réparée		Non rép.		Réparée		Non rép.		Réparée		Non rép.		Réparée		Non rép.		Réparée	
9-1/2"	NI-20	15'-6"	15'-7"	14'-8"	14'-9"	13'-11"	14'-3"	n.d.	n.d.	-	-	-	-	-	-	-	n.d.	n.d.	
	NI-40x	16'-6"	16'-7"	15'-7"	15'-8"	15'-0"	15'-1"	n.d.	n.d.	16'-5"	16'-7"	-	-	-	-	-	n.d.	n.d.	
	NI-60	16'-8"	16'-9"	15'-8"	15'-9"	15'-2"	15'-3"	n.d.	n.d.	16'-7"	16'-9"	15'-7"	15'-9"	-	-	-	n.d.	n.d.	
	NI-80	17'-7"	17'-8"	16'-7"	16'-7"	15'-11"	16'-0"	n.d.	n.d.	17'-6"	17'-8"	16'-6"	16'-7"	15'-11"	16'-0"	-	n.d.	n.d.	
11-7/8"	NI-20	17'-5"	17'-6"	16'-6"	16'-7"	15'-11"	16'-0"	n.d.	n.d.	17'-5"	17'-6"	15'-8"	16'-7"	14'-4"	16'-0"	-	n.d.	n.d.	
	NI-40x	18'-8"	18'-9"	17'-5"	17'-6"	16'-10"	16'-11"	n.d.	n.d.	18'-7"	18'-9"	16'-7"	17'-6"	15'-1"	16'-10"	-	n.d.	n.d.	
	NI-60	18'-11"	19'-0"	17'-7"	17'-8"	17'-0"	17'-1"	n.d.	n.d.	18'-10"	19'-0"	17'-7"	17'-8"	16'-11"	17'-1"	-	n.d.	n.d.	
	NI-80	20'-3"	20'-4"	18'-9"	18'-10"	17'-11"	18'-0"	n.d.	n.d.	20'-2"	20'-4"	18'-8"	18'-10"	17'-10"	18'-0"	-	n.d.	n.d.	
14"	NI-90	20'-8"	20'-9"	19'-1"	19'-2"	18'-3"	18'-4"	n.d.	n.d.	20'-7"	20'-9"	19'-0"	19'-2"	18'-2"	18'-4"	-	n.d.	n.d.	
	NI-40x	20'-9"	20'-10"	19'-3"	19'-4"	18'-5"	18'-6"	n.d.	n.d.	20'-8"	20'-10"	18'-4"	19'-4"	16'-7"	18'-6"	-	n.d.	n.d.	
	NI-60	21'-1"	21'-2"	19'-7"	19'-8"	18'-8"	18'-9"	n.d.	n.d.	21'-0"	21'-2"	19'-6"	19'-8"	18'-7"	18'-9"	-	n.d.	n.d.	
	NI-80	22'-6"	22'-7"	20'-10"	20'-11"	19'-11"	20'-0"	n.d.	n.d.	22'-5"	22'-7"	20'-9"	20'-11"	19'-10"	20'-0"	-	n.d.	n.d.	
16"	NI-90	23'-0"	23'-0"	21'-3"	21'-4"	20'-3"	20'-4"	n.d.	n.d.	22'-11"	23'-0"	21'-2"	21'-4"	20'-2"	20'-4"	-	n.d.	n.d.	
	NI-60	23'-0"	23'-1"	21'-4"	21'-5"	20'-5"	20'-6"	n.d.	n.d.	22'-11"	23'-1"	21'-3"	21'-5"	20'-4"	20'-6"	-	n.d.	n.d.	
	NI-80	24'-7"	24'-8"	22'-9"	22'-10"	21'-8"	21'-9"	n.d.	n.d.	24'-6"	24'-8"	22'-8"	22'-10"	21'-7"	21'-9"	-	n.d.	n.d.	
	NI-90	25'-0"	25'-1"	23'-2"	23'-2"	22'-1"	22'-2"	n.d.	n.d.	24'-11"	25'-1"	23'-0"	23'-2"	22'-0"	22'-2"	-	n.d.	n.d.	

Notes :

1. Les portées libres indiquées s'appliquent à la construction de planchers résidentiels respectant les critères de conception ci-dessus.
2. La longueur d'appui minimale est de 1-3/4 pouce pour les appuis d'extrémité et de 3-1/2 pouces pour les appuis intermédiaires.
3. Les raidisseurs d'appui ne sont pas requis lorsque les solives sont utilisées conformément à ces tableaux, sauf si requis pour les étriers.
4. Pour les hypothèses de calcul, voir la page 1. Pour le détail de réparation, voir la page 2.

Critères de conception

Profondeur de l'entaille :	1 po
Portée :	Portées multiples
Charges :	Surcharge = 40 lbf/pi ² et charge permanente = 15 lbf/pi ²
Limites de flèche :	L/480 sous la surcharge et L/240 sous la charge totale
Revêtement :	Panneaux de copeaux orientés (OSB) 5/8 po, cloué et collé

Portées maximales de plancher

Solive seule

Hauteur	Série	Position de l'entaille (x) ≤ 4 pi								Position de l'entaille (x) ≤ 8 pi							
		Espaceur centre/centre								Espaceur centre/centre							
		12"		16"		19.2"		24"		12"		16"		19.2"		24"	
		Non rép.	Réparée	Non rép.	Réparée	Non rép.	Réparée	Non rép.	Réparée	Non rép.	Réparée	Non rép.	Réparée	Non rép.	Réparée	Non rép.	Réparée
9-1/2"	NI-20	16'-2"	16'-3"	15'-3"	15'-4"	14'-9"	14'-10"	n.d.	n.d.	16'-1"	16'-3"	-	-	-	-	n.d.	n.d.
	NI-40x	17'-4"	17'-5"	16'-4"	16'-5"	15'-9"	15'-10"	n.d.	n.d.	17'-3"	17'-5"	16'-3"	16'-5"	15'-8"	15'-10"	n.d.	n.d.
	NI-60	17'-6"	17'-7"	16'-6"	16'-7"	15'-11"	16'-0"	n.d.	n.d.	17'-5"	17'-7"	16'-5"	16'-7"	15'-10"	16'-0"	n.d.	n.d.
	NI-80	18'-9"	18'-10"	17'-5"	17'-6"	16'-10"	16'-11"	n.d.	n.d.	18'-8"	18'-10"	17'-5"	17'-6"	16'-9"	16'-11"	n.d.	n.d.
11-7/8"	NI-20	18'-4"	18'-5"	17'-2"	17'-3"	16'-7"	16'-9"	n.d.	n.d.	18'-3"	18'-5"	17'-1"	17'-3"	16'-7"	16'-9"	n.d.	n.d.
	NI-40x	19'-11"	20'-0"	18'-5"	18'-7"	17'-8"	17'-9"	n.d.	n.d.	19'-9"	20'-0"	18'-4"	18'-7"	17'-7"	17'-9"	n.d.	n.d.
	NI-60	20'-2"	20'-3"	18'-8"	18'-10"	17'-10"	18'-0"	n.d.	n.d.	20'-1"	20'-3"	18'-7"	18'-10"	17'-10"	18'-0"	n.d.	n.d.
	NI-80	21'-9"	21'-10"	20'-1"	20'-2"	19'-2"	19'-3"	n.d.	n.d.	21'-7"	21'-10"	20'-0"	20'-2"	19'-1"	19'-3"	n.d.	n.d.
14"	NI-20	22'-2"	22'-3"	20'-6"	20'-7"	19'-7"	19'-8"	n.d.	n.d.	22'-1"	22'-3"	20'-5"	20'-7"	19'-6"	19'-8"	n.d.	n.d.
	NI-40x	22'-1"	22'-2"	20'-5"	20'-7"	19'-7"	19'-8"	n.d.	n.d.	22'-0"	22'-2"	20'-4"	20'-7"	19'-6"	19'-8"	n.d.	n.d.
	NI-60	22'-5"	22'-7"	20'-9"	20'-11"	19'-10"	20'-0"	n.d.	n.d.	22'-4"	22'-7"	20'-8"	20'-11"	19'-9"	20'-0"	n.d.	n.d.
	NI-80	24'-2"	24'-3"	22'-4"	22'-5"	21'-4"	21'-5"	n.d.	n.d.	24'-1"	24'-3"	22'-3"	22'-5"	21'-3"	21'-5"	n.d.	n.d.
16"	NI-60	24'-8"	24'-9"	22'-9"	22'-10"	21'-9"	21'-10"	n.d.	n.d.	24'-7"	24'-9"	22'-8"	22'-10"	21'-8"	21'-10"	n.d.	n.d.
	NI-80	24'-6"	24'-7"	22'-8"	22'-10"	21'-8"	21'-9"	n.d.	n.d.	24'-5"	24'-7"	22'-7"	22'-10"	21'-7"	21'-9"	n.d.	n.d.
	NI-90	26'-4"	26'-5"	24'-4"	24'-5"	23'-2"	23'-4"	n.d.	n.d.	26'-3"	26'-5"	24'-3"	24'-5"	23'-1"	23'-4"	n.d.	n.d.
	NI-90	26'-10"	26'-11"	24'-9"	24'-11"	23'-8"	23'-9"	n.d.	n.d.	26'-9"	26'-11"	24'-8"	24'-11"	23'-7"	23'-9"	n.d.	n.d.

Plaque de plâtre 1/2 po

Hauteur	Série	Position de l'entaille (x) ≤ 4 pi								Position de l'entaille (x) ≤ 8 pi							
		Espaceur centre/centre								Espaceur centre/centre							
		12"		16"		19.2"		24"		12"		16"		19.2"		24"	
		Non rép.	Réparée	Non rép.	Réparée	Non rép.	Réparée	Non rép.	Réparée	Non rép.	Réparée	Non rép.	Réparée	Non rép.	Réparée	Non rép.	Réparée
9-1/2"	NI-20	16'-9"	16'-10"	15'-10"	15'-11"	15'-4"	15'-5"	n.d.	n.d.	16'-8"	16'-10"	15'-9"	15'-11"	-	-	n.d.	n.d.
	NI-40x	17'-10"	17'-11"	16'-10"	16'-11"	16'-3"	16'-4"	n.d.	n.d.	17'-9"	17'-11"	16'-9"	16'-11"	16'-2"	16'-4"	n.d.	n.d.
	NI-60	18'-0"	18'-1"	16'-11"	17'-0"	16'-4"	16'-5"	n.d.	n.d.	17'-11"	18'-1"	16'-11"	17'-0"	16'-4"	16'-5"	n.d.	n.d.
	NI-80	19'-4"	19'-5"	17'-11"	18'-0"	17'-3"	17'-4"	n.d.	n.d.	19'-3"	19'-5"	17'-10"	18'-0"	17'-2"	17'-4"	n.d.	n.d.
11-7/8"	NI-20	19'-2"	19'-3"	17'-10"	17'-11"	17'-3"	17'-4"	n.d.	n.d.	19'-1"	19'-3"	17'-9"	17'-11"	17'-2"	17'-4"	n.d.	n.d.
	NI-40x	20'-7"	20'-8"	19'-2"	19'-3"	18'-4"	18'-5"	n.d.	n.d.	20'-6"	20'-8"	19'-1"	19'-3"	18'-3"	18'-5"	n.d.	n.d.
	NI-60	20'-11"	21'-0"	19'-5"	19'-6"	18'-7"	18'-8"	n.d.	n.d.	20'-10"	21'-0"	19'-4"	19'-6"	18'-6"	18'-8"	n.d.	n.d.
	NI-80	22'-4"	22'-5"	20'-9"	20'-10"	19'-9"	19'-10"	n.d.	n.d.	22'-3"	22'-5"	20'-8"	20'-10"	19'-9"	19'-10"	n.d.	n.d.
14"	NI-20	22'-10"	22'-11"	21'-2"	21'-2"	20'-2"	20'-3"	n.d.	n.d.	22'-9"	22'-11"	21'-1"	21'-2"	20'-1"	20'-3"	n.d.	n.d.
	NI-40x	22'-11"	23'-0"	21'-3"	21'-4"	20'-4"	20'-6"	n.d.	n.d.	22'-10"	23'-0"	21'-3"	21'-4"	20'-4"	20'-6"	n.d.	n.d.
	NI-60	23'-3"	23'-4"	21'-7"	21'-8"	20'-8"	20'-9"	n.d.	n.d.	23'-2"	23'-4"	21'-6"	21'-8"	20'-7"	20'-9"	n.d.	n.d.
	NI-80	24'-11"	25'-0"	23'-1"	23'-2"	22'-0"	22'-1"	n.d.	n.d.	24'-10"	25'-0"	23'-0"	23'-2"	21'-11"	22'-1"	n.d.	n.d.
16"	NI-60	25'-5"	25'-6"	23'-6"	23'-7"	22'-5"	22'-6"	n.d.	n.d.	25'-4"	25'-6"	23'-5"	23'-7"	22'-4"	22'-6"	n.d.	n.d.
	NI-80	25'-5"	25'-6"	23'-7"	23'-8"	22'-7"	22'-8"	n.d.	n.d.	25'-4"	25'-6"	23'-6"	23'-8"	22'-6"	22'-8"	n.d.	n.d.
	NI-90	27'-2"	27'-3"	25'-2"	25'-3"	24'-0"	24'-1"	n.d.	n.d.	27'-1"	27'-3"	25'-1"	25'-3"	23'-11"	24'-1"	n.d.	n.d.
	NI-90	27'-8"	27'-9"	25'-7"	25'-8"	24'-5"	24'-6"	n.d.	n.d.	27'-7"	27'-9"	25'-6"	25'-8"	24'-4"	24'-6"	n.d.	n.d.

Notes :

1. Les portées libres indiquées s'appliquent à la construction de planchers résidentiels respectant les critères de conception ci-dessus.
2. La longueur d'appui minimale est de 1-3/4 pouce pour les appuis d'extrémité et de 3-1/2 pouces pour les appuis intermédiaires.
3. Les raidisseurs d'appui ne sont pas requis lorsque les solives sont utilisées conformément à ces tableaux, sauf si requis pour les étriers.
4. Pour les hypothèses de calcul, voir la page 1. Pour le détail de réparation, voir la page 2.

Critères de conception

Profondeur de l'entaille :	1 po
Portée :	Portée simple
Charges :	Surcharge = 40 lbf/pi ² et charge permanente = 15 lbf/pi ²
Limites de flèche :	L/480 sous la surcharge et L/240 sous la charge totale
Revêtement :	Panneaux de copeaux orientés (OSB) 3/4 po, cloué et collé

Portées maximales de plancher

Solive seule

Hauteur	Série	Position de l'entaille (x) ≤ 4 pi								Position de l'entaille (x) ≤ 8 pi							
		Espaceur centre/centre								Espaceur centre/centre							
		12"		16"		19.2"		24"		12"		16"		19.2"		24"	
		Non rép.	Réparée	Non rép.	Réparée	Non rép.	Réparée	Non rép.	Réparée	Non rép.	Réparée	Non rép.	Réparée	Non rép.	Réparée		
9-1/2"	NI-20	15'-10"	15'-11"	14'-11"	15'-0"	13'-11"	14'-6"	11'-11"	13'-5"	15'-9"	15'-11"	-	-	-	-	-	
	NI-40x	16'-11"	17'-0"	15'-11"	16'-0"	15'-1"	15'-5"	12'-10"	14'-10"	16'-10"	17'-0"	14'-7"	16'-0"	-	-	-	
	NI-60	17'-1"	17'-2"	16'-1"	16'-2"	15'-6"	15'-7"	14'-10"	14'-11"	17'-0"	17'-2"	16'-0"	16'-2"	-	-	-	
	NI-80	18'-2"	18'-3"	17'-0"	17'-1"	16'-4"	16'-5"	15'-8"	15'-9"	18'-1"	18'-3"	16'-11"	17'-1"	16'-4"	16'-5"	15'-7"	15'-9"
11-7/8"	NI-20	17'-9"	17'-11"	16'-9"	16'-11"	16'-2"	16'-3"	14'-3"	15'-8"	17'-9"	17'-11"	15'-8"	16'-11"	14'-4"	16'-0"	-	
	NI-40x	19'-3"	19'-4"	17'-10"	17'-11"	17'-2"	17'-3"	15'-5"	16'-7"	19'-2"	19'-4"	16'-7"	17'-11"	15'-1"	16'-10"	-	
	NI-60	19'-6"	19'-7"	18'-1"	18'-2"	17'-4"	17'-6"	16'-7"	16'-9"	19'-5"	19'-7"	18'-0"	18'-2"	17'-3"	17'-6"	15'-6"	16'-9"
	NI-80	21'-0"	21'-1"	19'-4"	19'-6"	18'-5"	18'-6"	17'-6"	17'-7"	20'-10"	21'-1"	19'-3"	19'-6"	18'-4"	18'-6"	17'-6"	17'-7"
14"	NI-90	21'-5"	21'-6"	19'-9"	19'-10"	18'-10"	18'-11"	17'-10"	17'-11"	21'-4"	21'-6"	19'-8"	19'-10"	18'-9"	18'-11"	17'-9"	17'-11"
	NI-40x	21'-4"	21'-5"	19'-9"	19'-11"	18'-10"	18'-11"	17'-10"	18'-0"	21'-3"	21'-5"	18'-4"	19'-11"	16'-7"	18'-7"	14'-10"	16'-6"
	NI-60	21'-8"	21'-10"	20'-1"	20'-2"	19'-1"	19'-3"	18'-1"	18'-3"	21'-7"	21'-10"	20'-0"	20'-2"	19'-0"	19'-3"	17'-0"	18'-3"
	NI-80	23'-4"	23'-5"	21'-6"	21'-7"	20'-6"	20'-7"	19'-4"	19'-5"	23'-3"	23'-5"	21'-5"	21'-7"	20'-5"	20'-7"	19'-3"	19'-5"
16"	NI-90	23'-9"	23'-10"	21'-11"	22'-1"	20'-10"	21'-0"	19'-9"	19'-10"	23'-8"	23'-10"	21'-10"	22'-1"	20'-9"	21'-0"	19'-8"	19'-10"
	NI-60	23'-8"	23'-9"	21'-11"	22'-0"	20'-10"	21'-0"	19'-9"	19'-10"	23'-7"	23'-9"	21'-10"	22'-0"	20'-9"	21'-0"	18'-6"	19'-10"
	NI-80	25'-5"	25'-6"	23'-5"	23'-7"	22'-4"	22'-5"	21'-1"	21'-2"	25'-4"	25'-6"	23'-4"	23'-7"	22'-3"	22'-5"	21'-0"	21'-2"
	NI-90	25'-11"	26'-0"	23'-11"	24'-0"	22'-8"	22'-10"	21'-5"	21'-6"	25'-10"	26'-0"	23'-10"	24'-0"	22'-7"	22'-10"	21'-4"	21'-6"

Plaque de plâtre 1/2 po

Hauteur	Série	Position de l'entaille (x) ≤ 4 pi								Position de l'entaille (x) ≤ 8 pi							
		Espaceur centre/centre								Espaceur centre/centre							
		12"		16"		19.2"		24"		12"		16"		19.2"		24"	
		Non rép.	Réparée	Non rép.	Réparée	Non rép.	Réparée	Non rép.	Réparée	Non rép.	Réparée	Non rép.	Réparée	Non rép.	Réparée		
9-1/2"	NI-20	16'-4"	16'-5"	15'-3"	15'-5"	13'-11"	14'-6"	11'-11"	13'-5"	15'-11"	16'-5"	-	-	-	-	-	
	NI-40x	17'-4"	17'-5"	16'-4"	16'-5"	15'-1"	15'-10"	12'-10"	14'-11"	16'-10"	17'-5"	14'-7"	16'-2"	-	-	-	
	NI-60	17'-6"	17'-7"	16'-6"	16'-7"	15'-10"	16'-0"	15'-2"	15'-4"	17'-5"	17'-7"	16'-5"	16'-7"	15'-2"	16'-0"	-	
	NI-80	18'-7"	18'-8"	17'-4"	17'-5"	16'-9"	16'-9"	16'-0"	16'-1"	18'-6"	18'-8"	17'-4"	17'-5"	16'-8"	16'-9"	15'-11"	16'-1"
11-7/8"	NI-20	18'-5"	18'-7"	17'-4"	17'-5"	16'-9"	16'-10"	14'-3"	16'-2"	18'-3"	18'-7"	15'-8"	17'-5"	14'-4"	16'-0"	-	
	NI-40x	19'-10"	19'-11"	18'-5"	18'-6"	17'-8"	17'-9"	15'-5"	17'-0"	19'-5"	19'-11"	16'-7"	18'-6"	15'-1"	16'-10"	-	
	NI-60	20'-1"	20'-2"	18'-8"	18'-9"	17'-10"	17'-11"	17'-1"	17'-2"	20'-0"	20'-2"	18'-7"	18'-9"	17'-4"	17'-11"	15'-6"	16'-10"
	NI-80	21'-6"	21'-7"	19'-11"	20'-0"	18'-11"	19'-0"	17'-11"	18'-0"	21'-5"	21'-7"	19'-10"	20'-0"	18'-11"	19'-0"	17'-10"	18'-0"
14"	NI-90	21'-11"	22'-0"	20'-3"	20'-4"	19'-4"	19'-5"	18'-3"	18'-4"	21'-10"	22'-0"	20'-2"	20'-4"	19'-3"	19'-5"	18'-2"	18'-4"
	NI-40x	22'-0"	22'-1"	20'-6"	20'-7"	19'-6"	19'-7"	17'-10"	18'-7"	21'-10"	22'-1"	18'-4"	20'-7"	16'-7"	18'-7"	14'-10"	16'-6"
	NI-60	22'-5"	22'-6"	20'-9"	20'-10"	19'-10"	19'-11"	18'-9"	18'-10"	22'-4"	22'-6"	20'-8"	20'-10"	19'-4"	19'-11"	17'-0"	18'-8"
	NI-80	23'-11"	24'-0"	22'-2"	22'-3"	21'-1"	21'-2"	19'-11"	20'-0"	23'-10"	24'-0"	22'-1"	22'-3"	21'-0"	21'-2"	19'-10"	20'-0"
16"	NI-90	24'-4"	24'-5"	22'-7"	22'-7"	21'-6"	21'-6"	20'-3"	20'-4"	24'-3"	24'-5"	22'-6"	22'-7"	21'-5"	21'-6"	20'-2"	20'-4"
	NI-60	24'-5"	24'-6"	22'-8"	22'-9"	21'-7"	21'-8"	20'-6"	20'-7"	24'-4"	24'-6"	22'-7"	22'-9"	21'-2"	21'-8"	18'-6"	20'-4"
	NI-80	26'-1"	26'-2"	24'-2"	24'-3"	23'-0"	23'-1"	21'-9"	21'-10"	26'-0"	26'-2"	24'-1"	24'-3"	22'-11"	23'-1"	21'-8"	21'-10"
	NI-90	26'-6"	26'-7"	24'-7"	24'-8"	23'-4"	23'-5"	22'-1"	22'-2"	26'-5"	26'-7"	24'-6"	24'-8"	23'-3"	23'-5"	22'-0"	22'-2"

Notes :

1. Les portées libres indiquées s'appliquent à la construction de planchers résidentiels respectant les critères de conception ci-dessus.
2. La longueur d'appui minimale est de 1-3/4 pouce pour les appuis d'extrémité et de 3-1/2 pouces pour les appuis intermédiaires.
3. Les raidisseurs d'appui ne sont pas requis lorsque les solives sont utilisées conformément à ces tableaux, sauf si requis pour les étriers.
4. Pour les hypothèses de calcul, voir la page 1. Pour le détail de réparation, voir la page 2.

Critères de conception

Profondeur de l'entaille :	1 po
Portée :	Portées multiples
Charges :	Surcharge = 40 lbf/pi ² et charge permanente = 15 lbf/pi ²
Limites de flèche :	L/480 sous la surcharge et L/240 sous la charge totale
Revêtement :	Panneaux de copeaux orientés (OSB) 3/4 po, cloué et collé

Portées maximales de plancher

Solive seule

Hauteur	Série	Position de l'entaille (x) ≤ 4 pi								Position de l'entaille (x) ≤ 8 pi							
		Espaceur centre/centre								Espaceur centre/centre							
		12"		16"		19.2"		24"		12"		16"		19.2"		24"	
		Non rép.	Réparée	Non rép.	Réparée	Non rép.	Réparée	Non rép.	Réparée	Non rép.	Réparée	Non rép.	Réparée	Non rép.	Réparée		
9-1/2"	NI-20	17'-0"	17'-2"	16'-1"	16'-2"	15'-6"	15'-8"	14'-5"	14'-7"	17'-0"	17'-2"	16'-0"	16'-2"	-	-	-	
	NI-40x	18'-4"	18'-5"	17'-2"	17'-3"	16'-6"	16'-8"	15'-5"	15'-5"	18'-3"	18'-5"	17'-1"	17'-3"	16'-6"	16'-8"	-	
	NI-60	18'-7"	18'-8"	17'-4"	17'-5"	16'-8"	16'-10"	16'-0"	16'-1"	18'-6"	18'-8"	17'-3"	17'-5"	16'-8"	16'-10"	15'-11"	16'-1"
	NI-80	20'-0"	20'-1"	18'-6"	18'-7"	17'-8"	17'-9"	16'-11"	17'-0"	19'-11"	20'-1"	18'-5"	18'-7"	17'-7"	17'-9"	16'-10"	17'-0"
11-7/8"	NI-20	19'-6"	19'-8"	18'-2"	18'-3"	17'-5"	17'-7"	16'-7"	16'-7"	19'-6"	19'-8"	18'-1"	18'-3"	17'-4"	17'-7"	16'-3"	16'-7"
	NI-40x	21'-2"	21'-4"	19'-8"	19'-9"	18'-9"	18'-10"	17'-7"	17'-7"	21'-1"	21'-4"	19'-7"	19'-9"	18'-8"	18'-10"	17'-0"	17'-7"
	NI-60	21'-6"	21'-8"	19'-11"	20'-1"	19'-0"	19'-1"	18'-0"	18'-1"	21'-5"	21'-8"	19'-10"	20'-1"	18'-11"	19'-1"	17'-11"	18'-1"
	NI-80	23'-2"	23'-3"	21'-5"	21'-6"	20'-4"	20'-5"	19'-3"	19'-4"	23'-1"	23'-3"	21'-4"	21'-6"	20'-3"	20'-5"	19'-2"	19'-4"
14"	NI-20	23'-8"	23'-9"	21'-10"	21'-11"	20'-9"	20'-10"	19'-8"	19'-9"	23'-7"	23'-9"	21'-9"	21'-11"	20'-8"	20'-10"	19'-7"	19'-9"
	NI-40x	23'-6"	23'-8"	21'-9"	21'-11"	20'-9"	20'-11"	19'-4"	19'-4"	23'-5"	23'-8"	21'-8"	21'-11"	20'-8"	20'-11"	18'-6"	19'-4"
	NI-60	23'-11"	24'-1"	22'-2"	22'-3"	21'-1"	21'-3"	20'-0"	20'-1"	23'-10"	24'-1"	22'-1"	22'-3"	21'-0"	21'-3"	19'-11"	20'-1"
	NI-80	25'-9"	25'-10"	23'-9"	23'-10"	22'-7"	22'-9"	21'-4"	21'-6"	25'-8"	25'-10"	23'-8"	23'-10"	22'-6"	22'-9"	21'-4"	21'-6"
16"	NI-60	26'-3"	26'-4"	24'-3"	24'-4"	23'-1"	23'-2"	21'-9"	21'-11"	26'-2"	26'-4"	24'-2"	24'-4"	23'-0"	23'-2"	21'-8"	21'-11"
	NI-80	26'-1"	26'-3"	24'-2"	24'-3"	23'-0"	23'-2"	21'-9"	21'-11"	26'-0"	26'-3"	24'-1"	24'-3"	22'-11"	23'-2"	21'-8"	21'-11"
	NI-80	28'-1"	28'-2"	25'-11"	26'-0"	24'-8"	24'-9"	23'-3"	23'-5"	27'-11"	28'-2"	25'-10"	26'-0"	24'-7"	24'-9"	23'-2"	23'-5"
	NI-90	28'-7"	28'-8"	26'-5"	26'-6"	25'-1"	25'-2"	23'-8"	23'-10"	28'-6"	28'-8"	26'-4"	26'-6"	25'-0"	25'-2"	23'-7"	23'-10"

Plaque de plâtre 1/2 po

Hauteur	Série	Position de l'entaille (x) ≤ 4 pi								Position de l'entaille (x) ≤ 8 pi							
		Espaceur centre/centre								Espaceur centre/centre							
		12"		16"		19.2"		24"		12"		16"		19.2"		24"	
		Non rép.	Réparée	Non rép.	Réparée	Non rép.	Réparée	Non rép.	Réparée	Non rép.	Réparée	Non rép.	Réparée	Non rép.	Réparée		
9-1/2"	NI-20	17'-7"	17'-8"	16'-7"	16'-9"	15'-8"	15'-9"	14'-5"	14'-7"	17'-6"	17'-8"	16'-6"	16'-9"	15'-6"	15'-9"	-	-
	NI-40x	18'-11"	19'-0"	17'-8"	17'-9"	17'-0"	17'-1"	15'-5"	15'-5"	18'-10"	19'-0"	17'-7"	17'-9"	16'-9"	17'-1"	-	-
	NI-60	19'-2"	19'-3"	17'-10"	17'-11"	17'-2"	17'-3"	16'-5"	16'-6"	19'-1"	19'-3"	17'-9"	17'-11"	17'-1"	17'-3"	16'-5"	16'-6"
	NI-80	20'-6"	20'-7"	19'-0"	19'-1"	18'-2"	18'-3"	17'-4"	17'-5"	20'-5"	20'-7"	18'-11"	19'-1"	18'-1"	18'-3"	17'-3"	17'-5"
11-7/8"	NI-20	20'-4"	20'-6"	19'-0"	19'-1"	18'-2"	18'-3"	16'-7"	16'-7"	20'-4"	20'-6"	18'-11"	19'-1"	17'-11"	18'-3"	16'-3"	16'-7"
	NI-40x	21'-11"	22'-0"	20'-4"	20'-6"	19'-5"	19'-6"	17'-7"	17'-7"	21'-10"	22'-0"	20'-4"	20'-6"	18'-10"	19'-6"	17'-0"	17'-7"
	NI-60	22'-2"	22'-3"	20'-7"	20'-9"	19'-8"	19'-9"	18'-8"	18'-9"	22'-1"	22'-3"	20'-7"	20'-9"	19'-7"	19'-9"	18'-7"	18'-9"
	NI-80	23'-9"	23'-10"	22'-0"	22'-1"	21'-0"	21'-1"	19'-10"	19'-11"	23'-8"	23'-10"	21'-11"	22'-1"	20'-11"	21'-1"	19'-9"	19'-11"
14"	NI-20	24'-3"	24'-4"	22'-5"	22'-6"	21'-4"	21'-5"	20'-3"	20'-4"	24'-2"	24'-4"	22'-4"	22'-6"	21'-3"	21'-5"	20'-2"	20'-4"
	NI-40x	24'-4"	24'-5"	22'-7"	22'-9"	21'-7"	21'-8"	19'-4"	19'-4"	24'-3"	24'-5"	22'-7"	22'-9"	20'-8"	21'-8"	18'-6"	19'-4"
	NI-60	24'-9"	24'-10"	23'-0"	23'-1"	21'-11"	22'-0"	20'-9"	20'-10"	24'-8"	24'-10"	22'-11"	23'-1"	21'-10"	22'-0"	20'-8"	20'-10"
	NI-80	26'-5"	26'-6"	24'-6"	24'-7"	23'-4"	23'-5"	22'-1"	22'-2"	26'-4"	26'-6"	24'-5"	24'-7"	23'-3"	23'-5"	22'-0"	22'-2"
16"	NI-60	26'-11"	27'-0"	24'-11"	25'-0"	23'-9"	23'-10"	22'-5"	22'-6"	26'-10"	27'-0"	24'-10"	25'-0"	23'-8"	23'-10"	22'-5"	22'-6"
	NI-80	27'-0"	27'-1"	25'-1"	25'-2"	23'-11"	24'-0"	22'-8"	22'-9"	26'-11"	27'-1"	25'-0"	25'-2"	23'-10"	24'-0"	22'-7"	22'-9"
	NI-80	28'-10"	28'-10"	26'-8"	26'-9"	25'-5"	25'-6"	24'-1"	24'-2"	28'-9"	28'-10"	26'-7"	26'-9"	25'-4"	25'-6"	24'-0"	24'-2"
	NI-90	29'-4"	29'-5"	27'-2"	27'-3"	25'-10"	25'-11"	24'-5"	24'-6"	29'-3"	29'-5"	27'-1"	27'-3"	25'-9"	25'-11"	24'-5"	24'-6"

Notes :

1. Les portées libres indiquées s'appliquent à la construction de planchers résidentiels respectant les critères de conception ci-dessus.
2. La longueur d'appui minimale est de 1-3/4 pouce pour les appuis d'extrémité et de 3-1/2 pouces pour les appuis intermédiaires.
3. Les raidisseurs d'appui ne sont pas requis lorsque les solives sont utilisées conformément à ces tableaux, sauf si requis pour les étriers.
4. Pour les hypothèses de calcul, voir la page 1. Pour le détail de réparation, voir la page 2.