

Nordic I-Joists with a Side Top Flange Notch

The purpose of this technical note is to guide builders in case of damage caused to Nordic I-joists.

This technical note only applies if the following assumptions are met:

1. Maximum of one notch per I-joist.
2. Notch on the side of the top flange.
3. Notch depth up to 1 inch.
4. Notch width up to 4 inches.
5. For multiple spans, the end spans are 40% or more of the adjacent span and the notch is located between the mid-span and the end (see the drawing at the bottom left).
6. Uniformly distributed loads.

For all other cases, here are the options:

- a. Replace the damaged joist;
- b. Add a new joist within three inches of the notched joist;
 - Verify sheathing span limits for the increased spacing.
 - Verify simple span joist resistance.
- c. Contact Nordic Technical Support.

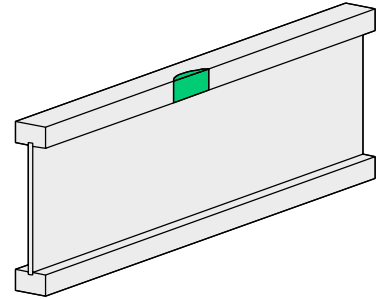

The following tables provide the maximum spans for Nordic I-joists with a side top flange notch, for simple and multiple spans, notch depths of 1/2 and 1 inch, with and without repair. Note that when there are few differences, the spans are governed by the vibration criterion. The drawings below illustrate the notch location, x , as well as its depth and width.

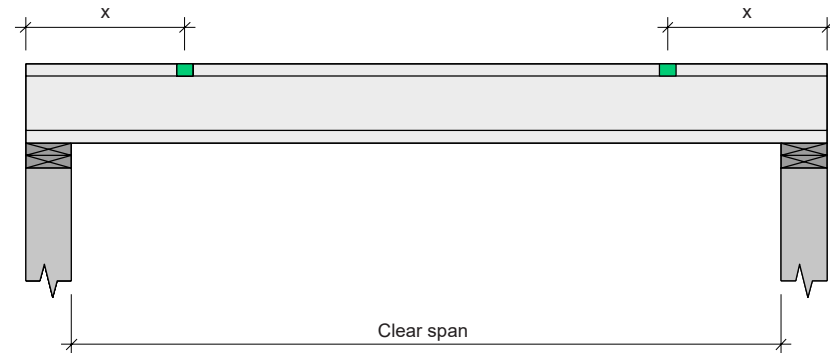

Elevation view of a simple-span joist and notch location

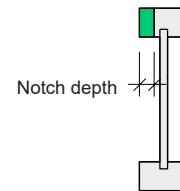

Section view of a side top flange notch

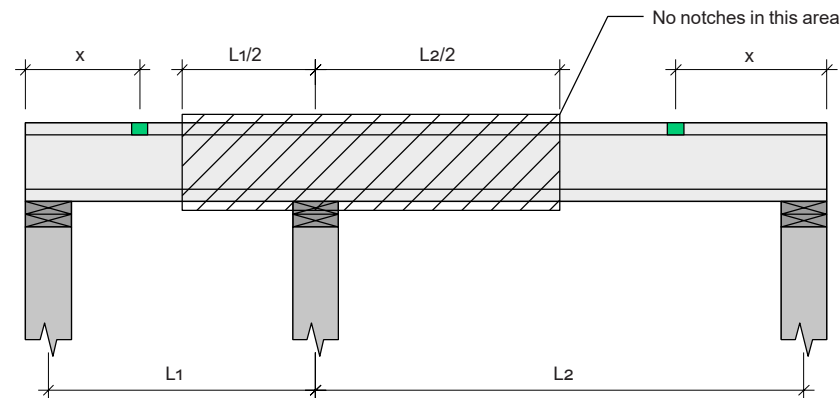

Elevation view of a multiple-span joist and notch location

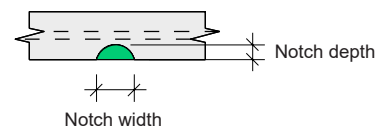

Top view of a side top flange notch

Repair Option for Nordic I-Joists with a Side Top Flange Notch

The following options are applicable to Nordic I-joists with a side top flange notch, only if the assumptions described on page 1 are met. In the following tables, the «No repair» columns indicate the allowable spans requiring no repair, while the «Repair» columns indicate the allowable spans when a repair is required.

Repair detail:

1. Install a 2x4 S-P-F No. 2 or better reinforcement, at least 4 feet long, on one side of the top flange.
2. The reinforcement must be centered on the notch, or installed from the support if the notch is at a distance of 2 feet or less from the support.
3. Attach the reinforcement with 2-1/2-inch common nails at 3 inches o.c., as shown.

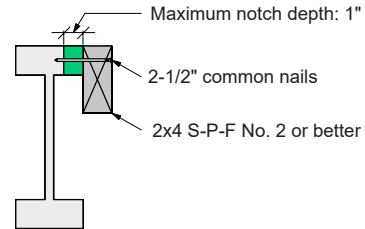

Section view of a repaired I-joist

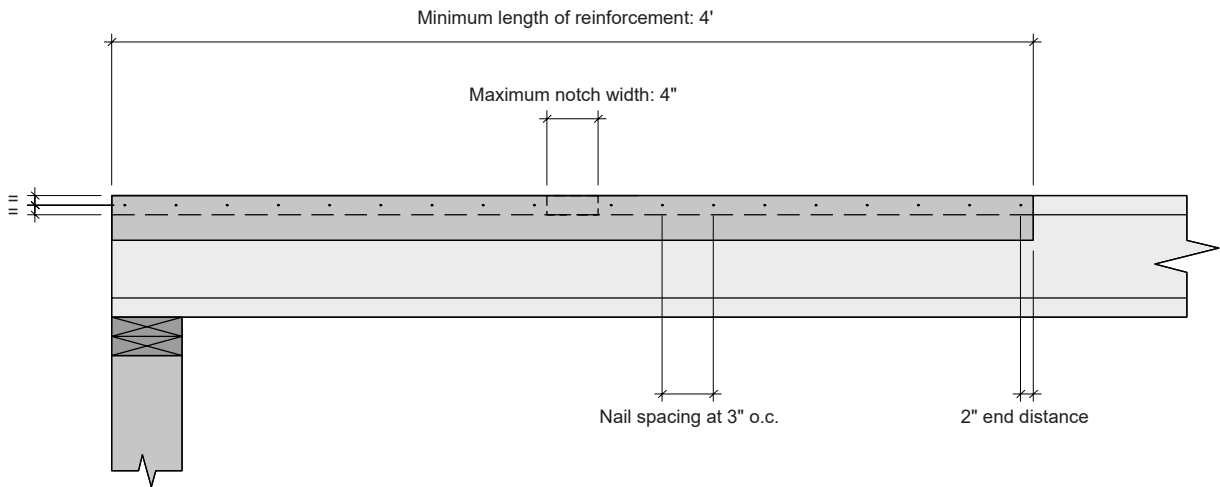

Elevation view of a repaired I-joist

Design Criteria

Notch depth:	1/2 inch
Span:	Simple span
Loads:	Live load = 40 psf and dead load = 15 psf
Deflection limits:	L/480 under live load and L/240 under total load
Sheathing:	5/8 inch nailed-glued oriented strand board (OSB) sheathing

Maximum Floor Spans

Bare joist

Joist depth	Joist series	Notch location (x) ≤ 4 ft								Notch location (x) ≤ 8 ft							
		On centre spacing								On centre spacing							
		12"		16"		19.2"		24"		12"		16"		19.2"		24"	
		No repair	Repair	No repair	Repair	No repair	Repair	No repair	Repair	No repair	Repair	No repair	Repair	No repair	Repair	No repair	Repair
9-1/2"	NI-20	15'-1"	15'-1"	14'-3"	14'-3"	13'-9"	13'-10"	n.a.	n.a.	-	-	-	-	-	-	n.a.	n.a.
	NI-40x	16'-1"	16'-2"	15'-2"	15'-3"	14'-8"	14'-8"	n.a.	n.a.	16'-1"	16'-2"	-	-	-	-	n.a.	n.a.
	NI-60	16'-3"	16'-4"	15'-4"	15'-4"	14'-10"	14'-10"	n.a.	n.a.	16'-3"	16'-4"	-	-	-	-	n.a.	n.a.
	NI-80	17'-3"	17'-3"	16'-3"	16'-3"	15'-8"	15'-8"	n.a.	n.a.	17'-3"	17'-3"	16'-2"	16'-3"	-	-	n.a.	n.a.
11-7/8"	NI-20	16'-11"	17'-0"	16'-0"	16'-0"	15'-6"	15'-6"	n.a.	n.a.	16'-11"	17'-0"	16'-0"	16'-0"	-	-	n.a.	n.a.
	NI-40x	18'-1"	18'-2"	17'-0"	17'-1"	16'-5"	16'-6"	n.a.	n.a.	18'-1"	18'-2"	17'-0"	17'-1"	16'-5"	16'-6"	n.a.	n.a.
	NI-60	18'-4"	18'-5"	17'-2"	17'-3"	16'-7"	16'-8"	n.a.	n.a.	18'-4"	18'-5"	17'-2"	17'-3"	16'-7"	16'-8"	n.a.	n.a.
	NI-80	19'-9"	19'-9"	18'-3"	18'-3"	17'-6"	17'-7"	n.a.	n.a.	19'-8"	19'-9"	18'-2"	18'-3"	17'-6"	17'-7"	n.a.	n.a.
14"	NI-20	20'-2"	20'-2"	18'-7"	18'-8"	17'-10"	17'-10"	n.a.	n.a.	20'-1"	20'-2"	18'-7"	18'-8"	17'-9"	17'-10"	n.a.	n.a.
	NI-40x	20'-0"	20'-1"	18'-7"	18'-8"	17'-10"	17'-10"	n.a.	n.a.	20'-0"	20'-1"	18'-7"	18'-8"	17'-10"	17'-10"	n.a.	n.a.
	NI-60	20'-5"	20'-6"	18'-10"	18'-11"	18'-1"	18'-2"	n.a.	n.a.	20'-5"	20'-6"	18'-10"	18'-11"	18'-1"	18'-2"	n.a.	n.a.
	NI-80	21'-11"	21'-11"	20'-3"	20'-3"	19'-4"	19'-4"	n.a.	n.a.	21'-10"	21'-11"	20'-3"	20'-3"	19'-4"	19'-4"	n.a.	n.a.
16"	NI-60	22'-5"	22'-5"	20'-8"	20'-8"	19'-9"	19'-9"	n.a.	n.a.	22'-4"	22'-5"	20'-7"	20'-8"	19'-8"	19'-9"	n.a.	n.a.
	NI-80	22'-3"	22'-4"	20'-7"	20'-8"	19'-8"	19'-9"	n.a.	n.a.	22'-3"	22'-4"	20'-7"	20'-8"	19'-8"	19'-9"	n.a.	n.a.
	NI-80	23'-11"	23'-11"	22'-1"	22'-1"	21'-1"	21'-1"	n.a.	n.a.	23'-10"	23'-11"	22'-0"	22'-1"	21'-0"	21'-1"	n.a.	n.a.
	NI-90	24'-4"	24'-5"	22'-6"	22'-6"	21'-5"	21'-6"	n.a.	n.a.	24'-4"	24'-5"	22'-5"	22'-6"	21'-5"	21'-6"	n.a.	n.a.

1/2 inch gypsum ceiling

Joist depth	Joist series	Notch location (x) ≤ 4 ft								Notch location (x) ≤ 8 ft							
		On centre spacing								On centre spacing							
		12"		16"		19.2"		24"		12"		16"		19.2"		24"	
		No repair	Repair	No repair	Repair	No repair	Repair	No repair	Repair	No repair	Repair	No repair	Repair	No repair	Repair	No repair	Repair
9-1/2"	NI-20	15'-7"	15'-7"	14'-8"	14'-9"	14'-3"	14'-3"	n.a.	n.a.	-	-	-	-	-	-	n.a.	n.a.
	NI-40x	16'-6"	16'-7"	15'-6"	15'-7"	15'-1"	15'-1"	n.a.	n.a.	16'-6"	16'-7"	-	-	-	-	n.a.	n.a.
	NI-60	16'-8"	16'-9"	15'-9"	15'-9"	15'-2"	15'-3"	n.a.	n.a.	16'-8"	16'-9"	15'-9"	15'-9"	-	-	n.a.	n.a.
	NI-80	17'-7"	17'-8"	16'-7"	16'-7"	16'-0"	16'-0"	n.a.	n.a.	17'-7"	17'-8"	16'-7"	16'-7"	16'-0"	16'-0"	n.a.	n.a.
11-7/8"	NI-20	17'-6"	17'-6"	16'-7"	16'-7"	16'-0"	16'-0"	n.a.	n.a.	17'-6"	17'-6"	16'-6"	16'-7"	16'-0"	16'-0"	n.a.	n.a.
	NI-40x	18'-9"	18'-9"	17'-6"	17'-6"	16'-11"	16'-11"	n.a.	n.a.	18'-8"	18'-9"	17'-6"	17'-6"	16'-11"	16'-11"	n.a.	n.a.
	NI-60	19'-0"	19'-0"	17'-8"	17'-8"	17'-1"	17'-1"	n.a.	n.a.	18'-11"	19'-0"	17'-8"	17'-8"	17'-1"	17'-1"	n.a.	n.a.
	NI-80	20'-4"	20'-4"	18'-9"	18'-10"	17'-11"	18'-0"	n.a.	n.a.	20'-3"	20'-4"	18'-9"	18'-10"	17'-11"	18'-0"	n.a.	n.a.
14"	NI-60	20'-8"	20'-9"	19'-2"	19'-2"	18'-3"	18'-4"	n.a.	n.a.	20'-8"	20'-9"	19'-1"	19'-2"	18'-3"	18'-4"	n.a.	n.a.
	NI-40x	20'-10"	20'-10"	19'-4"	19'-4"	18'-6"	18'-6"	n.a.	n.a.	20'-9"	20'-10"	19'-3"	19'-4"	18'-5"	18'-6"	n.a.	n.a.
	NI-60	21'-2"	21'-2"	19'-7"	19'-8"	18'-9"	18'-9"	n.a.	n.a.	21'-1"	21'-2"	19'-7"	19'-8"	18'-9"	18'-9"	n.a.	n.a.
	NI-80	22'-7"	22'-7"	20'-11"	20'-11"	19'-11"	20'-0"	n.a.	n.a.	22'-7"	22'-7"	20'-10"	20'-11"	19'-11"	20'-0"	n.a.	n.a.
16"	NI-90	23'-0"	23'-0"	21'-3"	21'-4"	20'-4"	20'-4"	n.a.	n.a.	22'-11"	23'-0"	21'-3"	21'-4"	20'-3"	20'-4"	n.a.	n.a.
	NI-60	23'-1"	23'-1"	21'-5"	21'-5"	20'-5"	20'-6"	n.a.	n.a.	23'-0"	23'-1"	21'-4"	21'-5"	20'-5"	20'-6"	n.a.	n.a.
	NI-80	24'-7"	24'-8"	22'-9"	22'-10"	21'-9"	21'-9"	n.a.	n.a.	24'-7"	24'-8"	22'-9"	22'-10"	21'-9"	21'-9"	n.a.	n.a.
	NI-90	25'-1"	25'-1"	23'-2"	23'-2"	22'-1"	22'-2"	n.a.	n.a.	25'-0"	25'-1"	23'-1"	23'-2"	22'-1"	22'-2"	n.a.	n.a.

Notes:

- The tabulated clear spans are applicable to residential floor construction meeting the above design criteria.
- Minimum bearing length shall be 1-3/4 inch for end bearings and 3-1/2 inches for intermediate bearings.
- Bearing stiffeners are not required when I-joists are used in accordance with this table, except as required for hangers.
- See page 1 for design assumptions. Repair shall be designed according to detail on page 2.

Design Criteria

Notch depth:	1/2 inch
Span:	Multiple spans
Loads:	Live load = 40 psf and dead load = 15 psf
Deflection limits:	L/480 under live load and L/240 under total load
Sheathing:	5/8 inch nailed-glued oriented strand board (OSB) sheathing

Maximum Floor Spans

Bare joist

Joist depth	Joist series	Notch location (x) ≤ 4 ft								Notch location (x) ≤ 8 ft							
		On centre spacing								On centre spacing							
		12"		16"		19.2"		24"		12"		16"		19.2"		24"	
		No repair	Repair	No repair	Repair	No repair	Repair	No repair	Repair	No repair	Repair	No repair	Repair	No repair	Repair	No repair	Repair
9-1/2"	NI-20	16'-3"	16'-3"	15'-4"	15'-4"	14'-10"	14'-10"	n.a.	n.a.	16'-2"	16'-3"	-	-	-	-	n.a.	n.a.
	NI-40x	17'-4"	17'-5"	16'-4"	16'-5"	15'-10"	15'-10"	n.a.	n.a.	17'-4"	17'-5"	16'-4"	16'-5"	15'-9"	15'-10"	n.a.	n.a.
	NI-60	17'-6"	17'-7"	16'-6"	16'-7"	16'-0"	16'-0"	n.a.	n.a.	17'-6"	17'-7"	16'-6"	16'-7"	15'-11"	16'-0"	n.a.	n.a.
	NI-80	18'-10"	18'-10"	17'-6"	17'-6"	16'-11"	16'-11"	n.a.	n.a.	18'-9"	18'-10"	17'-6"	17'-6"	16'-10"	16'-11"	n.a.	n.a.
11-7/8"	NI-20	18'-5"	18'-5"	17'-3"	17'-3"	16'-8"	16'-9"	n.a.	n.a.	18'-4"	18'-5"	17'-3"	17'-3"	16'-8"	16'-9"	n.a.	n.a.
	NI-40x	19'-11"	20'-0"	18'-6"	18'-7"	17'-9"	17'-9"	n.a.	n.a.	19'-11"	20'-0"	18'-6"	18'-7"	17'-9"	17'-9"	n.a.	n.a.
	NI-60	20'-2"	20'-3"	18'-9"	18'-10"	17'-11"	18'-0"	n.a.	n.a.	20'-2"	20'-3"	18'-9"	18'-10"	17'-11"	18'-0"	n.a.	n.a.
	NI-80	21'-9"	21'-10"	20'-2"	20'-2"	19'-3"	19'-3"	n.a.	n.a.	21'-9"	21'-10"	20'-1"	20'-2"	19'-2"	19'-3"	n.a.	n.a.
14"	NI-20	22'-3"	22'-3"	20'-7"	20'-7"	19'-8"	19'-8"	n.a.	n.a.	22'-3"	22'-3"	20'-6"	20'-7"	19'-7"	19'-8"	n.a.	n.a.
	NI-40x	22'-2"	22'-2"	20'-7"	20'-7"	19'-8"	19'-8"	n.a.	n.a.	22'-1"	22'-2"	20'-6"	20'-7"	19'-7"	19'-8"	n.a.	n.a.
	NI-60	22'-6"	22'-7"	20'-10"	20'-11"	19'-11"	20'-0"	n.a.	n.a.	22'-6"	22'-7"	20'-10"	20'-11"	19'-11"	20'-0"	n.a.	n.a.
	NI-80	24'-3"	24'-3"	22'-5"	22'-5"	21'-4"	21'-5"	n.a.	n.a.	24'-2"	24'-3"	22'-4"	22'-5"	21'-4"	21'-5"	n.a.	n.a.
16"	NI-20	24'-9"	24'-9"	22'-10"	22'-10"	21'-9"	21'-10"	n.a.	n.a.	24'-8"	24'-9"	22'-10"	22'-10"	21'-9"	21'-10"	n.a.	n.a.
	NI-40x	24'-6"	24'-7"	22'-10"	21'-8"	21'-8"	21'-9"	n.a.	n.a.	24'-6"	24'-7"	22'-9"	22'-9"	21'-8"	21'-9"	n.a.	n.a.
	NI-60	26'-5"	26'-5"	24'-5"	24'-5"	23'-3"	23'-4"	n.a.	n.a.	26'-5"	26'-5"	24'-4"	24'-5"	23'-3"	23'-4"	n.a.	n.a.
	NI-80	26'-11"	26'-11"	24'-10"	24'-11"	23'-8"	23'-9"	n.a.	n.a.	26'-11"	26'-11"	24'-10"	24'-11"	23'-8"	23'-9"	n.a.	n.a.

1/2 inch gypsum ceiling

Joist depth	Joist series	Notch location (x) ≤ 4 ft								Notch location (x) ≤ 8 ft							
		On centre spacing								On centre spacing							
		12"		16"		19.2"		24"		12"		16"		19.2"		24"	
		No repair	Repair	No repair	Repair	No repair	Repair	No repair	Repair	No repair	Repair	No repair	Repair	No repair	Repair	No repair	Repair
9-1/2"	NI-20	16'-9"	16'-10"	15'-10"	15'-11"	15'-4"	15'-5"	n.a.	n.a.	16'-9"	16'-10"	15'-10"	15'-11"	-	-	n.a.	n.a.
	NI-40x	17'-10"	17'-11"	16'-10"	16'-11"	16'-3"	16'-4"	n.a.	n.a.	17'-10"	17'-11"	16'-10"	16'-11"	16'-3"	16'-4"	n.a.	n.a.
	NI-60	18'-1"	18'-1"	17'-0"	17'-0"	16'-5"	16'-5"	n.a.	n.a.	18'-0"	18'-1"	17'-0"	17'-0"	16'-5"	16'-5"	n.a.	n.a.
	NI-80	19'-5"	19'-5"	17'-11"	18'-0"	17'-4"	17'-4"	n.a.	n.a.	19'-4"	19'-5"	17'-11"	18'-0"	17'-3"	17'-4"	n.a.	n.a.
11-7/8"	NI-20	19'-2"	19'-3"	17'-11"	17'-11"	17'-3"	17'-4"	n.a.	n.a.	19'-2"	19'-3"	17'-10"	17'-11"	17'-3"	17'-4"	n.a.	n.a.
	NI-40x	20'-8"	20'-8"	19'-3"	19'-3"	18'-5"	18'-5"	n.a.	n.a.	20'-8"	20'-8"	19'-2"	19'-3"	18'-4"	18'-5"	n.a.	n.a.
	NI-60	20'-11"	21'-0"	19'-6"	19'-6"	18'-7"	18'-8"	n.a.	n.a.	20'-11"	21'-0"	19'-5"	19'-6"	18'-7"	18'-8"	n.a.	n.a.
	NI-80	22'-5"	22'-5"	20'-9"	20'-10"	19'-10"	19'-10"	n.a.	n.a.	22'-5"	22'-5"	20'-9"	20'-10"	19'-10"	19'-10"	n.a.	n.a.
14"	NI-20	22'-11"	22'-11"	21'-2"	21'-2"	20'-3"	20'-3"	n.a.	n.a.	22'-10"	22'-11"	21'-2"	21'-2"	20'-2"	20'-3"	n.a.	n.a.
	NI-40x	23'-0"	23'-0"	21'-4"	21'-4"	20'-5"	20'-6"	n.a.	n.a.	22'-11"	23'-0"	21'-4"	21'-4"	20'-5"	20'-6"	n.a.	n.a.
	NI-60	23'-4"	23'-4"	21'-8"	21'-8"	20'-9"	20'-9"	n.a.	n.a.	23'-4"	23'-4"	21'-8"	21'-8"	20'-8"	20'-9"	n.a.	n.a.
	NI-80	25'-0"	25'-0"	23'-1"	23'-2"	22'-1"	22'-1"	n.a.	n.a.	24'-11"	25'-0"	23'-1"	23'-2"	22'-1"	22'-1"	n.a.	n.a.
16"	NI-20	25'-5"	25'-6"	23'-7"	23'-7"	22'-6"	22'-6"	n.a.	n.a.	25'-5"	25'-6"	23'-6"	23'-7"	22'-5"	22'-6"	n.a.	n.a.
	NI-40x	25'-6"	25'-6"	23'-8"	23'-8"	22'-8"	22'-8"	n.a.	n.a.	25'-5"	25'-6"	23'-7"	23'-8"	22'-7"	22'-8"	n.a.	n.a.
	NI-60	27'-3"	27'-3"	25'-3"	25'-3"	24'-1"	24'-1"	n.a.	n.a.	27'-2"	27'-3"	25'-2"	25'-2"	24'-1"	24'-1"	n.a.	n.a.
	NI-80	27'-9"	27'-9"	25'-8"	25'-8"	24'-6"	24'-6"	n.a.	n.a.	27'-8"	27'-9"	25'-7"	25'-8"	24'-5"	24'-6"	n.a.	n.a.

Notes:

- The tabulated clear spans are applicable to residential floor construction meeting the above design criteria.
- Minimum bearing length shall be 1-3/4 inch for end bearings and 3-1/2 inches for intermediate bearings.
- Bearing stiffeners are not required when I-joists are used in accordance with this table, except as required for hangers.
- See page 1 for design assumptions. Repair shall be designed according to detail on page 2.

Design Criteria

Notch depth:	1/2 inch
Span:	Simple span
Loads:	Live load = 40 psf and dead load = 15 psf
Deflection limits:	L/480 under live load and L/240 under total load
Sheathing:	3/4 inch nailed-glued oriented strand board (OSB) sheathing

Maximum Floor Spans

Bare joist

Joist depth	Joist series	Notch location (x) ≤ 4 ft								Notch location (x) ≤ 8 ft								
		On centre spacing								On centre spacing								
		12"		16"		19.2"		24"		12"		16"		19.2"		24"		
		No repair	Repair	No repair	Repair	No repair	Repair	No repair	Repair	No repair	Repair	No repair	Repair	No repair	Repair	No repair	Repair	
9-1/2"	NI-20	15'-11"	15'-11"	15'-0"	15'-1"	14'-5"	14'-6"	13'-4"	13'-5"	15'-10"	15'-11"	-	-	-	-	-	-	-
	NI-40x	17'-0"	17'-0"	16'-0"	16'-0"	15'-5"	15'-5"	14'-9"	14'-10"	16'-11"	17'-0"	15'-11"	16'-0"	-	-	-	-	-
	NI-60	17'-1"	17'-2"	16'-2"	16'-2"	15'-6"	15'-7"	14'-11"	14'-11"	17'-1"	17'-2"	16'-1"	16'-2"	-	-	-	-	-
	NI-80	18'-2"	18'-3"	17'-1"	17'-1"	16'-5"	16'-5"	15'-9"	15'-9"	18'-2"	18'-3"	17'-0"	17'-1"	16'-5"	16'-5"	15'-8"	15'-9"	-
11-7/8"	NI-20	17'-10"	17'-11"	16'-10"	16'-11"	16'-3"	16'-3"	15'-7"	15'-8"	17'-10"	17'-11"	16'-10"	16'-11"	16'-3"	16'-3"	-	-	-
	NI-40x	19'-4"	19'-4"	17'-11"	17'-11"	17'-3"	17'-3"	16'-6"	16'-7"	19'-3"	19'-4"	17'-11"	17'-11"	17'-3"	17'-3"	15'-8"	16'-7"	-
	NI-60	19'-6"	19'-7"	18'-2"	18'-2"	17'-5"	17'-6"	16'-8"	16'-9"	19'-6"	19'-7"	18'-1"	18'-2"	17'-5"	17'-6"	16'-8"	16'-9"	-
	NI-80	21'-0"	21'-1"	19'-5"	19'-6"	18'-5"	18'-6"	17'-6"	17'-7"	21'-0"	21'-1"	19'-5"	19'-6"	18'-5"	18'-6"	17'-6"	17'-7"	-
14"	NI-20	21'-6"	21'-6"	19'-9"	19'-10"	18'-10"	18'-11"	17'-10"	17'-11"	21'-5"	21'-6"	19'-9"	19'-10"	18'-10"	18'-11"	17'-10"	17'-11"	-
	NI-40x	21'-5"	21'-5"	19'-10"	19'-11"	18'-11"	18'-11"	17'-11"	18'-0"	21'-5"	21'-5"	19'-10"	19'-10"	18'-10"	18'-11"	17'-4"	18'-0"	-
	NI-60	21'-9"	21'-10"	20'-1"	20'-2"	19'-2"	19'-3"	18'-2"	18'-3"	21'-9"	21'-10"	20'-1"	20'-2"	19'-2"	19'-3"	18'-2"	18'-3"	-
	NI-80	23'-4"	23'-5"	21'-6"	21'-7"	20'-6"	20'-7"	19'-5"	19'-5"	23'-4"	23'-5"	21'-6"	21'-7"	20'-6"	20'-7"	19'-5"	19'-5"	-
16"	NI-20	23'-10"	23'-10"	22'-0"	22'-1"	20'-11"	21'-0"	19'-9"	19'-10"	23'-10"	23'-10"	22'-0"	22'-1"	20'-11"	21'-0"	19'-9"	19'-10"	-
	NI-40x	23'-8"	23'-9"	22'-0"	22'-0"	20'-11"	20'-11"	19'-10"	19'-10"	23'-8"	23'-9"	21'-11"	22'-0"	20'-11"	21'-0"	19'-9"	19'-10"	-
	NI-60	25'-6"	25'-6"	23'-6"	23'-7"	22'-4"	22'-5"	21'-2"	21'-2"	25'-5"	25'-6"	23'-6"	23'-7"	22'-4"	22'-5"	21'-1"	21'-2"	-
	NI-80	25'-11"	26'-0"	23'-11"	24'-0"	22'-9"	22'-10"	21'-5"	21'-6"	25'-11"	26'-0"	23'-11"	24'-0"	22'-9"	22'-10"	21'-5"	21'-6"	-

1/2 inch gypsum ceiling

Joist depth	Joist series	Notch location (x) ≤ 4 ft								Notch location (x) ≤ 8 ft								
		On centre spacing								On centre spacing								
		12"		16"		19.2"		24"		12"		16"		19.2"		24"		
		No repair	Repair	No repair	Repair	No repair	Repair	No repair	Repair	No repair	Repair	No repair	Repair	No repair	Repair	No repair	Repair	
9-1/2"	NI-20	16'-4"	16'-5"	15'-4"	15'-5"	14'-5"	14'-6"	13'-4"	13'-5"	16'-4"	16'-5"	-	-	-	-	-	-	-
	NI-40x	17'-4"	17'-5"	16'-5"	16'-5"	15'-9"	15'-10"	15'-1"	15'-2"	17'-4"	17'-5"	16'-4"	16'-5"	15'-5"	15'-10"	-	-	-
	NI-60	17'-6"	17'-7"	16'-6"	16'-7"	15'-11"	16'-0"	15'-3"	15'-4"	17'-6"	17'-7"	16'-6"	16'-7"	15'-11"	16'-0"	-	-	-
	NI-80	18'-8"	18'-8"	17'-5"	17'-5"	16'-9"	16'-9"	16'-1"	16'-1"	18'-7"	18'-8"	17'-5"	17'-5"	16'-9"	16'-9"	16'-0"	16'-1"	-
11-7/8"	NI-20	18'-6"	18'-7"	17'-5"	17'-5"	16'-9"	16'-10"	16'-1"	16'-2"	18'-6"	18'-7"	17'-4"	17'-5"	16'-8"	16'-10"	14'-11"	16'-2"	-
	NI-40x	19'-11"	19'-11"	18'-6"	18'-6"	17'-8"	17'-8"	17'-0"	17'-0"	19'-11"	19'-11"	18'-6"	18'-6"	17'-8"	17'-9"	15'-8"	17'-0"	-
	NI-60	20'-2"	20'-2"	18'-9"	18'-9"	17'-10"	17'-11"	17'-2"	17'-2"	20'-2"	20'-2"	18'-8"	18'-9"	17'-10"	17'-11"	17'-1"	17'-2"	-
	NI-80	21'-7"	21'-7"	20'-0"	20'-0"	19'-0"	19'-0"	18'-0"	18'-0"	21'-6"	21'-7"	19'-11"	20'-0"	19'-0"	19'-0"	18'-0"	18'-0"	-
14"	NI-20	22'-0"	22'-0"	20'-4"	20'-4"	19'-4"	19'-5"	18'-4"	18'-4"	21'-11"	22'-0"	20'-4"	20'-4"	19'-4"	19'-5"	18'-3"	18'-4"	-
	NI-40x	22'-1"	22'-1"	20'-6"	20'-7"	19'-7"	19'-7"	18'-7"	18'-7"	22'-1"	22'-1"	20'-6"	20'-7"	19'-7"	19'-7"	17'-4"	18'-7"	-
	NI-60	22'-5"	22'-6"	20'-9"	20'-10"	19'-10"	19'-11"	18'-9"	18'-10"	22'-5"	22'-6"	20'-9"	20'-10"	19'-10"	19'-11"	18'-9"	18'-10"	-
	NI-80	24'-0"	24'-0"	22'-2"	22'-3"	21'-2"	21'-2"	20'-0"	20'-0"	23'-11"	24'-0"	22'-2"	22'-3"	21'-1"	21'-2"	20'-0"	20'-0"	-
16"	NI-20	24'-5"	24'-5"	22'-7"	22'-7"	21'-6"	21'-6"	20'-4"	20'-4"	24'-5"	24'-5"	22'-7"	22'-7"	21'-6"	21'-6"	20'-4"	20'-4"	-
	NI-40x	24'-6"	24'-6"	22'-9"	22'-9"	21'-8"	21'-8"	20'-6"	20'-7"	24'-5"	24'-6"	22'-8"	22'-9"	21'-8"	21'-8"	20'-6"	20'-7"	-
	NI-60	26'-1"	26'-2"	24'-2"	24'-3"	23'-0"	23'-1"	21'-9"	21'-10"	26'-1"	26'-2"	24'-2"	24'-3"	23'-0"	23'-1"	21'-9"	21'-10"	-
	NI-80	26'-7"	26'-7"	24'-7"	24'-8"	23'-5"	23'-5"	22'-2"	22'-2"	26'-7"	26'-7"	24'-7"	24'-8"	23'-5"	23'-5"	22'-1"	22'-2"	-

Notes:

1. The tabulated clear spans are applicable to residential floor construction meeting the above design criteria.
2. Minimum bearing length shall be 1-3/4 inch for end bearings and 3-1/2 inches for intermediate bearings.
3. Bearing stiffeners are not required when I-joists are used in accordance with this table, except as required for hangers.
4. See page 1 for design assumptions. Repair shall be designed according to detail on page 2.

Design Criteria

Notch depth:	1/2 inch
Span:	Multiple spans
Loads:	Live load = 40 psf and dead load = 15 psf
Deflection limits:	L/480 under live load and L/240 under total load
Sheathing:	3/4 inch nailed-glued oriented strand board (OSB) sheathing

Maximum Floor Spans

Bare joist

Joist depth	Joist series	Notch location (x) ≤ 4 ft								Notch location (x) ≤ 8 ft							
		On centre spacing								On centre spacing							
		12"		16"		19.2"		24"		12"		16"		19.2"		24"	
		No repair	Repair	No repair	Repair	No repair	Repair	No repair	Repair	No repair	Repair	No repair	Repair	No repair	Repair	No repair	Repair
9-1/2"	NI-20	17'-1"	17'-2"	16'-2"	16'-2"	15'-7"	15'-8"	14'-6"	14'-7"	17'-1"	17'-2"	16'-2"	16'-2"	-	-	-	-
	NI-40x	18'-4"	18'-5"	17'-3"	17'-3"	16'-7"	16'-8"	15'-5"	15'-5"	18'-4"	18'-5"	17'-2"	17'-3"	16'-7"	16'-8"	-	-
	NI-60	18'-8"	18'-8"	17'-5"	17'-5"	16'-9"	16'-10"	16'-1"	16'-1"	18'-7"	18'-8"	17'-4"	17'-5"	16'-9"	16'-10"	16'-1"	16'-1"
	NI-80	20'-1"	20'-1"	18'-7"	18'-7"	17'-9"	17'-9"	17'-0"	17'-0"	20'-1"	20'-1"	18'-7"	18'-7"	17'-8"	17'-9"	16'-11"	17'-0"
11-7/8"	NI-20	19'-8"	19'-8"	18'-3"	18'-3"	17'-6"	17'-7"	16'-7"	16'-7"	19'-7"	19'-8"	18'-2"	18'-3"	17'-6"	17'-7"	16'-7"	16'-7"
	NI-40x	21'-3"	21'-4"	19'-9"	19'-9"	18'-10"	18'-10"	17'-7"	17'-7"	21'-3"	21'-4"	19'-8"	19'-9"	18'-9"	18'-10"	17'-7"	17'-7"
	NI-60	21'-7"	21'-8"	20'-0"	20'-1"	19'-1"	19'-1"	18'-1"	18'-1"	21'-7"	21'-8"	20'-0"	20'-1"	19'-0"	19'-1"	18'-0"	18'-1"
	NI-80	23'-2"	23'-3"	21'-5"	21'-6"	20'-4"	20'-5"	19'-3"	19'-4"	23'-2"	23'-3"	21'-5"	21'-6"	20'-4"	20'-5"	19'-3"	19'-4"
14"	NI-20	23'-8"	23'-8"	21'-10"	21'-11"	20'-10"	20'-11"	19'-4"	19'-4"	23'-7"	23'-8"	21'-10"	21'-11"	20'-10"	20'-11"	19'-4"	19'-4"
	NI-40x	23'-7"	23'-8"	21'-10"	21'-11"	20'-10"	20'-11"	19'-4"	19'-4"	23'-7"	23'-8"	21'-10"	21'-11"	20'-10"	20'-11"	19'-4"	19'-4"
	NI-60	24'-0"	24'-1"	22'-3"	22'-3"	21'-2"	21'-3"	20'-1"	20'-1"	24'-0"	24'-1"	22'-2"	22'-3"	21'-2"	21'-3"	20'-0"	20'-1"
	NI-80	25'-10"	25'-10"	23'-10"	23'-10"	22'-8"	22'-9"	21'-5"	21'-6"	25'-9"	25'-10"	23'-10"	23'-10"	22'-8"	22'-9"	21'-5"	21'-6"
16"	NI-20	26'-2"	26'-2"	24'-4"	24'-4"	23'-2"	23'-2"	21'-10"	21'-11"	26'-4"	26'-4"	24'-3"	24'-4"	23'-1"	23'-2"	21'-10"	21'-11"
	NI-40x	26'-2"	26'-2"	24'-3"	24'-3"	23'-1"	23'-2"	21'-10"	21'-11"	26'-2"	26'-3"	24'-2"	24'-3"	23'-1"	23'-2"	21'-10"	21'-11"
	NI-60	28'-1"	28'-2"	26'-0"	26'-0"	24'-8"	24'-8"	23'-4"	23'-5"	28'-1"	28'-2"	25'-11"	26'-0"	24'-8"	24'-9"	23'-4"	23'-5"
	NI-80	28'-8"	28'-8"	26'-6"	26'-6"	25'-2"	25'-2"	23'-9"	23'-10"	28'-8"	28'-8"	26'-5"	26'-6"	25'-2"	25'-2"	23'-9"	23'-10"

1/2 inch gypsum ceiling

Joist depth	Joist series	Notch location (x) ≤ 4 ft								Notch location (x) ≤ 8 ft							
		On centre spacing								On centre spacing							
		12"		16"		19.2"		24"		12"		16"		19.2"		24"	
		No repair	Repair	No repair	Repair	No repair	Repair	No repair	Repair	No repair	Repair	No repair	Repair	No repair	Repair	No repair	Repair
9-1/2"	NI-20	17'-8"	17'-8"	16'-8"	16'-9"	15'-9"	15'-9"	14'-6"	14'-7"	17'-8"	17'-8"	16'-8"	16'-9"	15'-8"	15'-9"	-	-
	NI-40x	19'-0"	19'-0"	17'-8"	17'-9"	17'-1"	17'-1"	15'-5"	15'-5"	19'-0"	19'-0"	17'-8"	17'-9"	17'-0"	17'-1"	-	-
	NI-60	19'-3"	19'-3"	17'-10"	17'-11"	17'-2"	17'-3"	16'-6"	16'-6"	19'-2"	19'-3"	17'-10"	17'-11"	17'-2"	17'-3"	16'-6"	16'-6"
	NI-80	20'-7"	20'-7"	19'-1"	19'-1"	18'-2"	18'-3"	17'-4"	17'-5"	20'-7"	20'-7"	19'-1"	19'-1"	18'-2"	18'-3"	17'-4"	17'-5"
11-7/8"	NI-20	20'-5"	20'-6"	19'-1"	19'-1"	18'-2"	18'-3"	16'-7"	16'-7"	20'-5"	20'-6"	19'-0"	19'-1"	18'-2"	18'-3"	16'-7"	16'-7"
	NI-40x	22'-0"	22'-0"	20'-5"	20'-6"	19'-6"	19'-6"	17'-7"	17'-7"	21'-11"	22'-0"	20'-5"	20'-6"	19'-6"	19'-6"	17'-7"	17'-7"
	NI-60	22'-3"	22'-3"	20'-8"	20'-9"	19'-9"	19'-9"	18'-9"	18'-9"	22'-3"	22'-3"	20'-8"	20'-9"	19'-9"	19'-9"	18'-8"	18'-9"
	NI-80	23'-10"	23'-10"	22'-1"	22'-1"	21'-0"	21'-1"	19'-11"	19'-11"	23'-9"	23'-10"	22'-0"	22'-1"	21'-0"	21'-1"	19'-10"	19'-11"
14"	NI-20	24'-3"	24'-4"	22'-6"	22'-6"	21'-5"	21'-5"	20'-3"	20'-4"	24'-3"	24'-4"	22'-6"	22'-6"	21'-5"	21'-5"	20'-3"	20'-4"
	NI-40x	24'-5"	24'-5"	22'-8"	22'-9"	21'-8"	21'-8"	19'-4"	19'-4"	24'-4"	24'-5"	22'-8"	22'-9"	21'-8"	21'-8"	19'-4"	19'-4"
	NI-60	24'-9"	24'-10"	23'-0"	23'-1"	22'-0"	22'-0"	20'-10"	20'-10"	24'-9"	24'-10"	23'-0"	23'-1"	21'-11"	22'-0"	20'-10"	20'-10"
	NI-80	26'-6"	26'-6"	24'-7"	24'-7"	23'-5"	23'-5"	22'-2"	22'-2"	26'-5"	26'-6"	24'-6"	24'-7"	23'-4"	23'-5"	22'-1"	22'-2"
16"	NI-20	27'-0"	27'-0"	25'-0"	25'-0"	23'-10"	23'-10"	22'-6"	22'-6"	26'-11"	27'-0"	25'-0"	25'-0"	23'-9"	23'-10"	22'-6"	22'-6"
	NI-40x	27'-0"	27'-0"	25'-0"	25'-0"	23'-10"	23'-10"	22'-6"	22'-6"	26'-11"	27'-0"	25'-0"	25'-0"	23'-9"	23'-10"	22'-6"	22'-6"
	NI-60	27'-0"	27'-1"	25'-1"	25'-2"	24'-0"	24'-0"	22'-9"	22'-9"	27'-0"	27'-1"	25'-1"	25'-2"	23'-11"	24'-0"	22'-8"	22'-9"
	NI-80	28'-10"	28'-10"	26'-9"	26'-9"	25'-6"	25'-6"	24'-1"	24'-2"	28'-10"	28'-10"	26'-9"	26'-9"	25'-6"	25'-6"	24'-1"	24'-2"
16"	NI-90	29'-5"	29'-5"	27'-3"	27'-3"	25'-11"	25'-11"	24'-6"	24'-6"	29'-4"	29'-5"	27'-2"	27'-3"	25'-11"	25'-11"	24'-6"	24'-6"

Notes:

- The tabulated clear spans are applicable to residential floor construction meeting the above design criteria.
- Minimum bearing length shall be 1-3/4 inch for end bearings and 3-1/2 inches for intermediate bearings.
- Bearing stiffeners are not required when I-joists are used in accordance with this table, except as required for hangers.
- See page 1 for design assumptions. Repair shall be designed according to detail on page 2.

Design Criteria

Notch depth:	1 inch
Span:	Simple span
Loads:	Live load = 40 psf and dead load = 15 psf
Deflection limits:	L/480 under live load and L/240 under total load
Sheathing:	5/8 inch nailed-glued oriented strand board (OSB) sheathing

Maximum Floor Spans

Bare joist

Joist depth	Joist series	Notch location (x) ≤ 4 ft								Notch location (x) ≤ 8 ft							
		On centre spacing								On centre spacing							
		12"		16"		19.2"		24"		12"		16"		19.2"		24"	
		No repair	Repair	No repair	Repair	No repair	Repair	No repair	Repair	No repair	Repair	No repair	Repair	No repair	Repair	No repair	Repair
9-1/2"	NI-20	15'-0"	15'-1"	14'-2"	14'-3"	13'-8"	13'-10"	n.a.	n.a.	-	-	-	-	-	-	n.a.	n.a.
	NI-40x	16'-1"	16'-2"	15'-1"	15'-3"	14'-7"	14'-8"	n.a.	n.a.	16'-0"	16'-2"	-	-	-	-	n.a.	n.a.
	NI-60	16'-2"	16'-4"	15'-3"	15'-4"	14'-9"	14'-10"	n.a.	n.a.	16'-2"	16'-4"	-	-	-	-	n.a.	n.a.
	NI-80	17'-2"	17'-3"	16'-2"	16'-3"	15'-7"	15'-8"	n.a.	n.a.	17'-1"	17'-3"	16'-1"	16'-3"	-	-	n.a.	n.a.
11-7/8"	NI-20	16'-11"	17'-0"	15'-11"	16'-0"	15'-5"	15'-6"	n.a.	n.a.	16'-10"	17'-0"	15'-8"	16'-0"	-	-	n.a.	n.a.
	NI-40x	18'-0"	18'-2"	16'-11"	17'-1"	16'-4"	16'-6"	n.a.	n.a.	17'-11"	18'-2"	16'-7"	17'-1"	15'-1"	16'-6"	n.a.	n.a.
	NI-60	18'-3"	18'-5"	17'-2"	17'-3"	16'-7"	16'-8"	n.a.	n.a.	18'-2"	18'-5"	17'-1"	17'-3"	16'-6"	16'-8"	n.a.	n.a.
	NI-80	19'-8"	19'-9"	18'-2"	18'-3"	17'-6"	17'-7"	n.a.	n.a.	19'-7"	19'-9"	18'-1"	18'-3"	17'-5"	17'-7"	n.a.	n.a.
14"	NI-90	20'-1"	20'-2"	18'-6"	18'-8"	17'-9"	17'-10"	n.a.	n.a.	20'-0"	20'-2"	18'-5"	18'-8"	17'-8"	17'-10"	n.a.	n.a.
	NI-40x	20'-0"	20'-1"	18'-6"	18'-8"	17'-9"	17'-10"	n.a.	n.a.	19'-11"	20'-1"	18'-4"	18'-8"	16'-7"	17'-10"	n.a.	n.a.
	NI-60	20'-4"	20'-6"	18'-10"	18'-11"	18'-0"	18'-2"	n.a.	n.a.	20'-3"	20'-6"	18'-9"	18'-11"	17'-11"	18'-2"	n.a.	n.a.
	NI-80	21'-10"	21'-11"	20'-2"	20'-3"	19'-3"	19'-4"	n.a.	n.a.	21'-9"	21'-11"	20'-1"	20'-3"	19'-2"	19'-4"	n.a.	n.a.
16"	NI-90	22'-4"	22'-5"	20'-7"	20'-8"	19'-8"	19'-9"	n.a.	n.a.	22'-3"	22'-5"	20'-6"	20'-8"	19'-7"	19'-9"	n.a.	n.a.
	NI-60	22'-2"	22'-4"	20'-6"	20'-8"	19'-8"	19'-9"	n.a.	n.a.	22'-1"	22'-4"	20'-5"	20'-8"	19'-7"	19'-9"	n.a.	n.a.
	NI-80	23'-10"	23'-11"	22'-0"	22'-1"	21'-0"	21'-1"	n.a.	n.a.	23'-9"	23'-11"	21'-11"	22'-1"	20'-11"	21'-1"	n.a.	n.a.
	NI-90	24'-4"	24'-5"	22'-5"	22'-6"	21'-5"	21'-6"	n.a.	n.a.	24'-3"	24'-5"	22'-4"	22'-6"	21'-3"	21'-6"	n.a.	n.a.

1/2 inch gypsum ceiling

Joist depth	Joist series	Notch location (x) ≤ 4 ft								Notch location (x) ≤ 8 ft							
		On centre spacing								On centre spacing							
		12"		16"		19.2"		24"		12"		16"		19.2"		24"	
		No repair	Repair	No repair	Repair	No repair	Repair	No repair	Repair	No repair	Repair	No repair	Repair	No repair	Repair	No repair	Repair
9-1/2"	NI-20	15'-6"	15'-7"	14'-8"	14'-9"	13'-11"	14'-3"	n.a.	n.a.	-	-	-	-	-	-	n.a.	n.a.
	NI-40x	16'-6"	16'-7"	15'-7"	15'-8"	15'-0"	15'-1"	n.a.	n.a.	16'-5"	16'-7"	-	-	-	-	n.a.	n.a.
	NI-60	16'-8"	16'-9"	15'-8"	15'-9"	15'-2"	15'-3"	n.a.	n.a.	16'-7"	16'-9"	15'-7"	15'-9"	-	-	n.a.	n.a.
	NI-80	17'-7"	17'-8"	16'-7"	16'-7"	15'-11"	16'-0"	n.a.	n.a.	17'-6"	17'-8"	16'-6"	16'-7"	15'-11"	16'-0"	n.a.	n.a.
11-7/8"	NI-20	17'-5"	17'-6"	16'-6"	16'-7"	15'-11"	16'-0"	n.a.	n.a.	17'-5"	17'-6"	15'-8"	16'-7"	14'-4"	16'-0"	n.a.	n.a.
	NI-40x	18'-8"	18'-9"	17'-5"	17'-6"	16'-10"	16'-11"	n.a.	n.a.	18'-7"	18'-9"	16'-7"	17'-6"	15'-1"	16'-10"	n.a.	n.a.
	NI-60	18'-11"	19'-0"	17'-7"	17'-8"	17'-0"	17'-1"	n.a.	n.a.	18'-10"	19'-0"	17'-7"	17'-8"	16'-11"	17'-1"	n.a.	n.a.
	NI-80	20'-3"	20'-4"	18'-9"	18'-10"	17'-11"	18'-0"	n.a.	n.a.	20'-2"	20'-4"	18'-8"	18'-10"	17'-10"	18'-0"	n.a.	n.a.
14"	NI-90	20'-8"	20'-9"	19'-1"	19'-2"	18'-3"	18'-4"	n.a.	n.a.	20'-7"	20'-9"	19'-0"	19'-2"	18'-2"	18'-4"	n.a.	n.a.
	NI-40x	20'-9"	20'-10"	19'-3"	19'-4"	18'-5"	18'-6"	n.a.	n.a.	20'-8"	20'-10"	18'-4"	19'-4"	16'-7"	18'-6"	n.a.	n.a.
	NI-60	21'-1"	21'-2"	19'-7"	19'-8"	18'-8"	18'-9"	n.a.	n.a.	21'-0"	21'-2"	19'-6"	19'-8"	18'-7"	18'-9"	n.a.	n.a.
	NI-80	22'-6"	22'-7"	20'-10"	20'-11"	19'-11"	20'-0"	n.a.	n.a.	22'-5"	22'-7"	20'-9"	20'-11"	19'-10"	20'-0"	n.a.	n.a.
16"	NI-90	23'-0"	23'-0"	21'-3"	21'-4"	20'-3"	20'-4"	n.a.	n.a.	22'-11"	23'-0"	21'-2"	21'-4"	20'-2"	20'-4"	n.a.	n.a.
	NI-60	23'-0"	23'-1"	21'-4"	21'-5"	20'-5"	20'-6"	n.a.	n.a.	22'-11"	23'-1"	21'-3"	21'-5"	20'-4"	20'-6"	n.a.	n.a.
	NI-80	24'-7"	24'-8"	22'-9"	22'-10"	21'-8"	21'-8"	n.a.	n.a.	24'-6"	24'-8"	22'-8"	22'-10"	21'-7"	21'-9"	n.a.	n.a.
	NI-90	25'-0"	25'-1"	23'-2"	23'-2"	22'-1"	22'-2"	n.a.	n.a.	24'-11"	25'-1"	23'-0"	23'-2"	22'-0"	22'-2"	n.a.	n.a.

Notes:

- The tabulated clear spans are applicable to residential floor construction meeting the above design criteria.
- Minimum bearing length shall be 1-3/4 inch for end bearings and 3-1/2 inches for intermediate bearings.
- Bearing stiffeners are not required when I-joists are used in accordance with this table, except as required for hangers.
- See page 1 for design assumptions. Repair shall be designed according to detail on page 2.

Design Criteria

Notch depth:	1 inch
Span:	Multiple spans
Loads:	Live load = 40 psf and dead load = 15 psf
Deflection limits:	L/480 under live load and L/240 under total load
Sheathing:	5/8 inch nailed-glued oriented strand board (OSB) sheathing

Maximum Floor Spans

Bare joist

Joist depth	Joist series	Notch location (x) ≤ 4 ft								Notch location (x) ≤ 8 ft							
		On centre spacing								On centre spacing							
		12"		16"		19.2"		24"		12"		16"		19.2"		24"	
		No repair	Repair	No repair	Repair	No repair	Repair	No repair	Repair	No repair	Repair	No repair	Repair	No repair	Repair	No repair	Repair
9-1/2"	NI-20	16'-2"	16'-3"	15'-3"	15'-4"	14'-9"	14'-10"	n.a.	n.a.	16'-1"	16'-3"	-	-	-	-	n.a.	n.a.
	NI-40x	17'-4"	17'-5"	16'-4"	16'-5"	15'-9"	15'-10"	n.a.	n.a.	17'-3"	17'-5"	16'-3"	16'-5"	15'-8"	15'-10"	n.a.	n.a.
	NI-60	17'-6"	17'-7"	16'-6"	16'-7"	15'-11"	16'-0"	n.a.	n.a.	17'-5"	17'-7"	16'-5"	16'-7"	15'-10"	16'-0"	n.a.	n.a.
	NI-80	18'-9"	18'-10"	17'-5"	17'-6"	16'-10"	16'-11"	n.a.	n.a.	18'-8"	18'-10"	17'-5"	17'-6"	16'-9"	16'-11"	n.a.	n.a.
11-7/8"	NI-20	18'-4"	18'-5"	17'-2"	17'-3"	16'-7"	16'-9"	n.a.	n.a.	18'-3"	18'-5"	17'-1"	17'-3"	16'-7"	16'-9"	n.a.	n.a.
	NI-40x	19'-11"	20'-0"	18'-5"	18'-7"	17'-8"	17'-9"	n.a.	n.a.	19'-9"	20'-0"	18'-4"	18'-7"	17'-7"	17'-9"	n.a.	n.a.
	NI-60	20'-2"	20'-3"	18'-8"	18'-10"	17'-10"	18'-0"	n.a.	n.a.	20'-1"	20'-3"	18'-7"	18'-10"	17'-10"	18'-0"	n.a.	n.a.
	NI-80	21'-9"	21'-10"	20'-1"	20'-2"	19'-2"	19'-3"	n.a.	n.a.	21'-7"	21'-10"	20'-0"	20'-2"	19'-1"	19'-3"	n.a.	n.a.
14"	NI-40x	22'-2"	22'-3"	20'-6"	20'-7"	19'-7"	19'-8"	n.a.	n.a.	22'-1"	22'-3"	20'-5"	20'-7"	19'-6"	19'-8"	n.a.	n.a.
	NI-60	22'-1"	22'-2"	20'-5"	20'-7"	19'-7"	19'-8"	n.a.	n.a.	22'-0"	22'-2"	20'-4"	20'-7"	19'-6"	19'-8"	n.a.	n.a.
	NI-80	22'-5"	22'-7"	20'-9"	20'-11"	19'-10"	20'-0"	n.a.	n.a.	22'-4"	22'-7"	20'-8"	20'-11"	19'-9"	20'-0"	n.a.	n.a.
	NI-90	24'-2"	24'-3"	22'-4"	22'-5"	21'-4"	21'-5"	n.a.	n.a.	24'-1"	24'-3"	22'-3"	22'-5"	21'-3"	21'-5"	n.a.	n.a.
16"	NI-60	24'-8"	24'-9"	22'-9"	22'-10"	21'-9"	21'-10"	n.a.	n.a.	24'-7"	24'-9"	22'-8"	22'-10"	21'-8"	21'-10"	n.a.	n.a.
	NI-80	24'-6"	24'-7"	22'-8"	22'-10"	21'-8"	21'-9"	n.a.	n.a.	24'-5"	24'-7"	22'-7"	22'-10"	21'-7"	21'-9"	n.a.	n.a.
	NI-90	26'-4"	26'-5"	24'-4"	24'-5"	23'-2"	23'-4"	n.a.	n.a.	26'-3"	26'-5"	24'-3"	24'-5"	23'-1"	23'-4"	n.a.	n.a.
	NI-90	26'-10"	26'-11"	24'-9"	24'-11"	23'-8"	23'-9"	n.a.	n.a.	26'-9"	26'-11"	24'-8"	24'-11"	23'-7"	23'-9"	n.a.	n.a.

1/2 inch gypsum ceiling

Joist depth	Joist series	Notch location (x) ≤ 4 ft								Notch location (x) ≤ 8 ft							
		On centre spacing								On centre spacing							
		12"		16"		19.2"		24"		12"		16"		19.2"		24"	
		No repair	Repair	No repair	Repair	No repair	Repair	No repair	Repair	No repair	Repair	No repair	Repair	No repair	Repair	No repair	Repair
9-1/2"	NI-20	16'-9"	16'-10"	15'-10"	15'-11"	15'-4"	15'-5"	n.a.	n.a.	16'-8"	16'-10"	15'-9"	15'-11"	-	-	n.a.	n.a.
	NI-40x	17'-10"	17'-11"	16'-10"	16'-11"	16'-3"	16'-3"	n.a.	n.a.	17'-9"	17'-11"	16'-9"	16'-11"	16'-2"	16'-4"	n.a.	n.a.
	NI-60	18'-0"	18'-1"	16'-11"	17'-0"	16'-4"	16'-5"	n.a.	n.a.	17'-11"	18'-1"	16'-11"	17'-0"	16'-4"	16'-5"	n.a.	n.a.
	NI-80	19'-4"	19'-5"	17'-11"	18'-0"	17'-3"	17'-4"	n.a.	n.a.	19'-3"	19'-5"	17'-10"	18'-0"	17'-2"	17'-4"	n.a.	n.a.
11-7/8"	NI-20	19'-2"	19'-3"	17'-10"	17'-11"	17'-3"	17'-4"	n.a.	n.a.	19'-1"	19'-3"	17'-9"	17'-11"	17'-2"	17'-4"	n.a.	n.a.
	NI-40x	20'-7"	20'-8"	19'-2"	19'-3"	18'-4"	18'-5"	n.a.	n.a.	20'-6"	20'-8"	19'-1"	19'-3"	18'-3"	18'-5"	n.a.	n.a.
	NI-60	20'-11"	21'-0"	19'-5"	19'-6"	18'-7"	18'-8"	n.a.	n.a.	20'-10"	21'-0"	19'-4"	19'-6"	18'-6"	18'-8"	n.a.	n.a.
	NI-80	22'-4"	22'-5"	20'-9"	20'-10"	19'-9"	19'-10"	n.a.	n.a.	22'-3"	22'-5"	20'-8"	20'-10"	19'-9"	19'-10"	n.a.	n.a.
14"	NI-90	22'-10"	22'-11"	21'-2"	21'-2"	20'-2"	20'-3"	n.a.	n.a.	22'-9"	22'-11"	21'-1"	21'-2"	20'-1"	20'-3"	n.a.	n.a.
	NI-40x	22'-11"	23'-0"	21'-3"	21'-4"	20'-4"	20'-6"	n.a.	n.a.	22'-10"	23'-0"	21'-3"	21'-4"	20'-4"	20'-6"	n.a.	n.a.
	NI-60	23'-3"	23'-4"	21'-7"	21'-8"	20'-8"	20'-9"	n.a.	n.a.	23'-2"	23'-4"	21'-6"	21'-8"	20'-7"	20'-9"	n.a.	n.a.
	NI-80	24'-11"	25'-0"	23'-1"	23'-2"	22'-0"	22'-1"	n.a.	n.a.	24'-10"	25'-0"	23'-0"	23'-2"	21'-11"	22'-1"	n.a.	n.a.
16"	NI-90	25'-5"	25'-6"	23'-6"	23'-7"	22'-5"	22'-6"	n.a.	n.a.	25'-4"	25'-6"	23'-5"	23'-7"	22'-4"	22'-6"	n.a.	n.a.
	NI-60	25'-5"	25'-6"	23'-7"	23'-8"	22'-7"	22'-8"	n.a.	n.a.	25'-4"	25'-6"	23'-6"	23'-8"	22'-6"	22'-8"	n.a.	n.a.
	NI-80	27'-2"	27'-3"	25'-2"	25'-3"	24'-0"	24'-1"	n.a.	n.a.	27'-1"	27'-3"	25'-1"	25'-3"	23'-11"	24'-1"	n.a.	n.a.
	NI-90	27'-8"	27'-9"	25'-7"	25'-8"	24'-5"	24'-6"	n.a.	n.a.	27'-7"	27'-9"	25'-6"	25'-8"	24'-4"	24'-6"	n.a.	n.a.

Notes:

- The tabulated clear spans are applicable to residential floor construction meeting the above design criteria.
- Minimum bearing length shall be 1-3/4 inch for end bearings and 3-1/2 inches for intermediate bearings.
- Bearing stiffeners are not required when I-joists are used in accordance with this table, except as required for hangers.
- See page 1 for design assumptions. Repair shall be designed according to detail on page 2.

Design Criteria

Notch depth:	1 inch
Span:	Simple span
Loads:	Live load = 40 psf and dead load = 15 psf
Deflection limits:	L/480 under live load and L/240 under total load
Sheathing:	3/4 inch nailed-glued oriented strand board (OSB) sheathing

Maximum Floor Spans

Bare joist

Joist depth	Joist series	Notch location (x) ≤ 4 ft								Notch location (x) ≤ 8 ft								
		On centre spacing								On centre spacing								
		12"		16"		19.2"		24"		12"		16"		19.2"		24"		
		No repair	Repair	No repair	Repair	No repair	Repair	No repair	Repair	No repair	Repair	No repair	Repair	No repair	Repair	No repair	Repair	
9-1/2"	NI-20	15'-10"	15'-11"	14'-11"	15'-0"	13'-11"	14'-6"	11'-11"	13'-5"	15'-9"	15'-11"	-	-	-	-	-	-	-
	NI-40x	16'-11"	17'-0"	15'-11"	16'-0"	15'-1"	15'-5"	12'-10"	14'-10"	16'-10"	17'-0"	14'-7"	16'-0"	-	-	-	-	-
	NI-60	17'-1"	17'-2"	16'-1"	16'-2"	15'-6"	15'-7"	14'-10"	14'-11"	17'-0"	17'-2"	16'-0"	16'-2"	-	-	-	-	-
	NI-80	18'-2"	18'-3"	17'-0"	17'-1"	16'-4"	16'-5"	15'-8"	15'-9"	18'-1"	18'-3"	16'-11"	17'-1"	16'-4"	16'-5"	15'-7"	15'-9"	-
11-7/8"	NI-20	17'-9"	17'-11"	16'-9"	16'-11"	16'-2"	16'-3"	14'-3"	15'-8"	17'-9"	17'-11"	15'-8"	16'-11"	14'-4"	16'-0"	-	-	-
	NI-40x	19'-3"	19'-4"	17'-10"	17'-11"	17'-2"	17'-3"	15'-5"	16'-7"	19'-2"	19'-4"	16'-7"	17'-11"	15'-1"	16'-10"	-	-	-
	NI-60	19'-6"	19'-7"	18'-1"	18'-2"	17'-4"	17'-6"	16'-7"	16'-9"	19'-5"	19'-7"	18'-0"	18'-2"	17'-3"	17'-6"	15'-6"	16'-9"	-
	NI-80	21'-0"	21'-1"	19'-4"	19'-6"	18'-5"	18'-6"	17'-6"	17'-7"	20'-10"	21'-1"	19'-3"	19'-6"	18'-4"	18'-6"	17'-6"	17'-7"	-
14"	NI-20	21'-5"	21'-6"	19'-9"	19'-10"	18'-10"	18'-11"	17'-10"	17'-11"	21'-4"	21'-6"	19'-8"	19'-10"	18'-9"	18'-11"	17'-9"	17'-11"	-
	NI-40x	21'-4"	21'-5"	19'-9"	19'-11"	18'-10"	18'-11"	17'-10"	18'-0"	21'-3"	21'-5"	18'-4"	19'-11"	16'-7"	18'-7"	14'-10"	16'-6"	-
	NI-60	21'-8"	21'-10"	20'-1"	20'-2"	19'-1"	19'-3"	18'-1"	18'-3"	21'-7"	21'-10"	20'-0"	20'-2"	19'-0"	19'-3"	17'-0"	18'-3"	-
	NI-80	23'-4"	23'-5"	21'-6"	21'-7"	20'-6"	20'-7"	19'-4"	19'-5"	23'-3"	23'-5"	21'-5"	21'-7"	20'-5"	20'-7"	19'-3"	19'-5"	-
16"	NI-20	23'-8"	23'-9"	21'-11"	22'-0"	20'-10"	21'-0"	19'-9"	19'-10"	23'-8"	23'-10"	21'-10"	22'-1"	20'-9"	21'-0"	19'-8"	19'-10"	-
	NI-40x	23'-8"	23'-9"	21'-11"	22'-0"	20'-10"	21'-0"	19'-9"	19'-10"	23'-7"	23'-9"	21'-10"	22'-0"	20'-9"	21'-0"	18'-6"	19'-10"	-
	NI-60	25'-5"	25'-6"	23'-5"	23'-7"	22'-4"	22'-5"	21'-1"	21'-2"	25'-4"	25'-6"	23'-4"	23'-7"	22'-3"	22'-5"	21'-0"	21'-2"	-
	NI-80	25'-11"	26'-0"	23'-11"	24'-0"	22'-8"	22'-10"	21'-5"	21'-6"	25'-10"	26'-0"	23'-10"	24'-0"	22'-7"	22'-10"	21'-4"	21'-6"	-

1/2 inch gypsum ceiling

Joist depth	Joist series	Notch location (x) ≤ 4 ft								Notch location (x) ≤ 8 ft								
		On centre spacing								On centre spacing								
		12"		16"		19.2"		24"		12"		16"		19.2"		24"		
		No repair	Repair	No repair	Repair	No repair	Repair	No repair	Repair	No repair	Repair	No repair	Repair	No repair	Repair	No repair	Repair	
9-1/2"	NI-20	16'-4"	16'-5"	15'-3"	15'-5"	13'-11"	14'-6"	11'-11"	13'-5"	15'-11"	16'-5"	-	-	-	-	-	-	-
	NI-40x	17'-4"	17'-5"	16'-4"	16'-5"	15'-1"	15'-10"	12'-10"	14'-11"	16'-10"	17'-5"	14'-7"	16'-2"	-	-	-	-	-
	NI-60	17'-6"	17'-7"	16'-6"	16'-7"	15'-10"	16'-0"	15'-2"	15'-4"	17'-5"	17'-7"	16'-5"	16'-7"	15'-2"	16'-0"	-	-	-
	NI-80	18'-7"	18'-8"	17'-4"	17'-5"	16'-9"	16'-9"	16'-0"	16'-1"	18'-6"	18'-8"	17'-4"	17'-5"	16'-8"	16'-9"	15'-11"	16'-1"	-
11-7/8"	NI-20	18'-5"	18'-7"	17'-4"	17'-5"	16'-9"	16'-10"	14'-3"	16'-2"	18'-3"	18'-7"	15'-8"	17'-5"	14'-4"	16'-0"	-	-	-
	NI-40x	19'-10"	19'-11"	18'-5"	18'-6"	17'-8"	17'-9"	15'-5"	17'-0"	19'-5"	19'-11"	16'-7"	18'-6"	15'-1"	16'-10"	-	-	-
	NI-60	20'-1"	20'-2"	18'-8"	18'-9"	17'-10"	17'-11"	17'-1"	17'-2"	20'-0"	20'-2"	18'-7"	18'-9"	17'-4"	17'-11"	15'-6"	16'-10"	-
	NI-80	21'-6"	21'-7"	19'-11"	20'-0"	18'-11"	19'-0"	17'-11"	18'-0"	21'-5"	21'-7"	19'-10"	20'-0"	18'-11"	19'-0"	17'-10"	18'-0"	-
14"	NI-20	21'-11"	22'-0"	20'-3"	20'-4"	19'-4"	19'-5"	18'-3"	18'-4"	21'-10"	22'-0"	20'-2"	20'-4"	19'-3"	19'-5"	18'-2"	18'-4"	-
	NI-40x	22'-0"	22'-1"	20'-6"	20'-7"	19'-6"	19'-7"	17'-10"	18'-7"	21'-10"	22'-1"	18'-4"	20'-7"	16'-7"	18'-7"	14'-10"	16'-6"	-
	NI-60	22'-5"	22'-6"	20'-9"	20'-10"	19'-10"	19'-11"	18'-9"	18'-10"	22'-4"	22'-6"	20'-8"	20'-10"	19'-4"	19'-11"	17'-0"	18'-8"	-
	NI-80	23'-11"	24'-0"	22'-2"	22'-3"	21'-1"	21'-2"	19'-11"	20'-0"	23'-10"	24'-0"	22'-1"	22'-3"	21'-0"	21'-2"	19'-10"	20'-0"	-
16"	NI-20	24'-4"	24'-5"	22'-7"	22'-7"	21'-6"	21'-6"	20'-3"	20'-4"	24'-3"	24'-5"	22'-6"	22'-7"	21'-5"	21'-6"	20'-2"	20'-4"	-
	NI-40x	24'-5"	24'-6"	22'-8"	22'-9"	21'-7"	21'-8"	20'-6"	20'-7"	24'-4"	24'-6"	22'-7"	22'-9"	21'-2"	21'-8"	18'-6"	20'-4"	-
	NI-60	26'-1"	26'-2"	24'-2"	24'-3"	23'-0"	23'-1"	21'-9"	21'-10"	26'-0"	26'-2"	24'-1"	24'-3"	22'-11"	23'-1"	21'-8"	21'-10"	-
	NI-80	26'-6"	26'-7"	24'-7"	24'-8"	23'-4"	23'-5"	22'-1"	22'-2"	26'-5"	26'-7"	24'-6"	24'-8"	23'-3"	23'-5"	22'-0"	22'-2"	-

Notes:

- The tabulated clear spans are applicable to residential floor construction meeting the above design criteria.
- Minimum bearing length shall be 1-3/4 inch for end bearings and 3-1/2 inches for intermediate bearings.
- Bearing stiffeners are not required when I-joists are used in accordance with this table, except as required for hangers.
- See page 1 for design assumptions. Repair shall be designed according to detail on page 2.

Design Criteria

Notch depth:	1 inch
Span:	Multiple spans
Loads:	Live load = 40 psf and dead load = 15 psf
Deflection limits:	L/480 under live load and L/240 under total load
Sheathing:	3/4 inch nailed-glued oriented strand board (OSB) sheathing

Maximum Floor Spans

Bare joist

Joist depth	Joist series	Notch location (x) ≤ 4 ft								Notch location (x) ≤ 8 ft							
		On centre spacing								On centre spacing							
		12"		16"		19.2"		24"		12"		16"		19.2"		24"	
No repair	Repair	No repair	Repair	No repair	Repair	No repair	Repair	No repair	Repair	No repair	Repair	No repair	Repair	No repair	Repair		
9-1/2"	NI-20	17'-0"	17'-2"	16'-1"	16'-2"	15'-6"	15'-8"	14'-5"	14'-7"	17'-0"	17'-2"	16'-0"	16'-2"	-	-	-	-
	NI-40x	18'-4"	18'-5"	17'-2"	17'-3"	16'-6"	16'-8"	15'-5"	15'-5"	18'-3"	18'-5"	17'-1"	17'-3"	16'-6"	16'-8"	-	-
	NI-60	18'-7"	18'-8"	17'-4"	17'-5"	16'-8"	16'-10"	16'-0"	16'-1"	18'-6"	18'-8"	17'-3"	17'-5"	16'-8"	16'-10"	15'-11"	16'-1"
	NI-80	20'-0"	20'-1"	18'-6"	18'-7"	17'-8"	17'-9"	16'-11"	17'-0"	19'-11"	20'-1"	18'-5"	18'-7"	17'-7"	17'-9"	16'-10"	17'-0"
11-7/8"	NI-20	19'-6"	19'-8"	18'-2"	18'-3"	17'-5"	17'-7"	16'-7"	16'-7"	19'-6"	19'-8"	18'-1"	18'-3"	17'-4"	17'-7"	16'-3"	16'-7"
	NI-40x	21'-2"	21'-4"	19'-8"	19'-9"	18'-9"	18'-10"	17'-7"	17'-7"	21'-1"	21'-4"	19'-7"	19'-9"	18'-8"	18'-10"	17'-0"	17'-7"
	NI-60	21'-6"	21'-8"	19'-11"	20'-1"	19'-0"	19'-1"	18'-0"	18'-1"	21'-5"	21'-8"	19'-10"	20'-1"	18'-11"	19'-1"	17'-11"	18'-1"
	NI-80	23'-2"	23'-3"	21'-5"	21'-6"	20'-4"	20'-5"	19'-3"	19'-4"	23'-1"	23'-3"	21'-4"	21'-6"	20'-3"	20'-5"	19'-2"	19'-4"
14"	NI-20	23'-8"	23'-9"	21'-10"	21'-11"	20'-9"	20'-10"	19'-8"	19'-9"	23'-7"	23'-9"	21'-9"	21'-11"	20'-8"	20'-10"	19'-7"	19'-9"
	NI-40x	23'-6"	23'-8"	21'-9"	21'-11"	20'-9"	20'-11"	19'-4"	19'-4"	23'-5"	23'-8"	21'-8"	21'-11"	20'-8"	20'-11"	18'-6"	19'-4"
	NI-60	23'-11"	24'-1"	22'-2"	22'-3"	21'-1"	21'-3"	20'-0"	20'-1"	23'-10"	24'-1"	22'-1"	22'-3"	21'-0"	21'-3"	19'-11"	20'-1"
	NI-80	25'-9"	25'-10"	23'-9"	23'-10"	22'-7"	22'-9"	21'-4"	21'-6"	25'-8"	25'-10"	23'-8"	23'-10"	22'-6"	22'-9"	21'-4"	21'-6"
16"	NI-20	26'-3"	26'-4"	24'-3"	24'-4"	23'-1"	23'-2"	21'-9"	21'-11"	26'-2"	26'-4"	24'-2"	24'-4"	23'-0"	23'-2"	21'-8"	21'-11"
	NI-40x	23'-6"	23'-8"	21'-9"	21'-11"	20'-9"	20'-11"	19'-4"	19'-4"	23'-5"	23'-8"	21'-8"	21'-11"	20'-8"	20'-11"	18'-6"	19'-4"
	NI-60	23'-11"	24'-1"	22'-2"	22'-3"	21'-1"	21'-3"	20'-0"	20'-1"	23'-10"	24'-1"	22'-1"	22'-3"	21'-0"	21'-3"	19'-11"	20'-1"
	NI-80	25'-9"	25'-10"	23'-9"	23'-10"	22'-7"	22'-9"	21'-4"	21'-6"	25'-8"	25'-10"	23'-8"	23'-10"	22'-6"	22'-9"	21'-4"	21'-6"

1/2 inch gypsum ceiling

Joist depth	Joist series	Notch location (x) ≤ 4 ft								Notch location (x) ≤ 8 ft							
		On centre spacing								On centre spacing							
		12"		16"		19.2"		24"		12"		16"		19.2"		24"	
No repair	Repair	No repair	Repair	No repair	Repair	No repair	Repair	No repair	Repair	No repair	Repair	No repair	Repair	No repair	Repair		
9-1/2"	NI-20	17'-7"	17'-8"	16'-7"	16'-9"	15'-8"	15'-9"	14'-5"	14'-7"	17'-6"	17'-8"	16'-6"	16'-9"	15'-6"	15'-9"	-	-
	NI-40x	18'-11"	19'-0"	17'-8"	17'-9"	17'-0"	17'-1"	15'-5"	15'-5"	18'-10"	19'-0"	17'-7"	17'-9"	16'-9"	17'-1"	-	-
	NI-60	19'-2"	19'-3"	17'-10"	17'-11"	17'-2"	17'-3"	16'-5"	16'-6"	19'-1"	19'-3"	17'-9"	17'-11"	17'-1"	17'-3"	16'-5"	16'-6"
	NI-80	20'-6"	20'-7"	19'-0"	19'-1"	18'-2"	18'-3"	17'-4"	17'-5"	20'-5"	20'-7"	18'-11"	19'-1"	18'-1"	18'-3"	17'-3"	17'-5"
11-7/8"	NI-20	20'-4"	20'-6"	19'-0"	19'-1"	18'-2"	18'-3"	16'-7"	16'-7"	20'-4"	20'-6"	18'-11"	19'-1"	17'-11"	18'-3"	16'-3"	16'-7"
	NI-40x	21'-11"	22'-0"	20'-4"	20'-6"	19'-5"	19'-6"	17'-7"	17'-7"	21'-10"	22'-0"	20'-4"	20'-6"	18'-10"	19'-6"	17'-0"	17'-7"
	NI-60	22'-2"	22'-3"	20'-7"	20'-9"	19'-8"	19'-9"	18'-8"	18'-9"	22'-1"	22'-3"	20'-7"	20'-9"	19'-7"	19'-9"	18'-7"	18'-9"
	NI-80	23'-9"	23'-10"	22'-0"	22'-1"	21'-0"	21'-1"	19'-10"	19'-11"	23'-8"	23'-10"	21'-11"	22'-1"	20'-11"	21'-1"	19'-9"	19'-11"
14"	NI-20	24'-3"	24'-4"	22'-5"	22'-6"	21'-4"	21'-5"	20'-3"	20'-4"	24'-2"	24'-4"	22'-4"	22'-6"	21'-3"	21'-5"	20'-2"	20'-4"
	NI-40x	24'-4"	24'-5"	22'-7"	22'-9"	21'-7"	21'-8"	19'-4"	19'-4"	24'-3"	24'-5"	22'-7"	22'-9"	20'-8"	21'-8"	18'-6"	19'-4"
	NI-60	24'-9"	24'-10"	23'-0"	23'-1"	21'-11"	22'-0"	20'-9"	20'-10"	24'-8"	24'-10"	22'-11"	23'-1"	21'-10"	22'-0"	20'-8"	20'-10"
	NI-80	26'-5"	26'-6"	24'-6"	24'-7"	23'-4"	23'-5"	22'-1"	22'-2"	26'-4"	26'-6"	24'-5"	24'-7"	23'-3"	23'-5"	22'-0"	22'-2"
16"	NI-20	26'-11"	27'-0"	24'-11"	25'-0"	23'-9"	23'-10"	22'-5"	22'-6"	26'-10"	27'-0"	24'-10"	25'-0"	23'-8"	23'-10"	22'-5"	22'-6"
	NI-40x	24'-4"	24'-5"	22'-7"	22'-9"	21'-7"	21'-8"	19'-4"	19'-4"	24'-3"	24'-5"	22'-7"	22'-9"	20'-8"	21'-8"	18'-6"	19'-4"
	NI-60	24'-9"	24'-10"	23'-0"	23'-1"	21'-11"	22'-0"	20'-9"	20'-10"	24'-8"	24'-10"	22'-11"	23'-1"	21'-10"	22'-0"	20'-8"	20'-10"
	NI-80	26'-5"	26'-6"	24'-6"	24'-7"	23'-4"	23'-5"	22'-1"	22'-2"	26'-4"	26'-6"	24'-5"	24'-7"	23'-3"	23'-5"	22'-0"	22'-2"

Notes:

- The tabulated clear spans are applicable to residential floor construction meeting the above design criteria.
- Minimum bearing length shall be 1-3/4 inch for end bearings and 3-1/2 inches for intermediate bearings.
- Bearing stiffeners are not required when I-joists are used in accordance with this table, except as required for hangers.
- See page 1 for design assumptions. Repair shall be designed according to detail on page 2.